

The AUSTRALASIAN

# Wireless

REVIEW

PRICE 1/6



**JOHN HENRY**  
THE DISCOVERER OF RADIO-FREQUENCY

MAY

1923



# The New Stars of the Radio World BROADCASTING—RECEPTION

The Graham Coil and Variable Condenser provide tuning equipment, unsurpassed for selectivity, sharpness and all round efficiency.

## THE GRAHAM VARIABLE CONDENSER (Patented)



THIS wonderful condenser fulfills every requirement of any condenser for any part of any wireless circuit, and is a distinct improvement over any other condenser, some of its features are as follows:—

It carries you through the whole range required from about .001 to .001 m.f. It has a gradual micro-meter action throughout its whole range. It is so accurate that it is already being used in wavemeter construction. There is no capacity effect from the body, a tremendous advantage. It is insulated to stand 2000 volts and is easy to mount. There are no Rotary plates, and it cannot get out of order or short. It has a full 360 degree dial instead of only 180, a big advantage. It occupies only a quarter the space of an ordinary condenser, and is ready for panel or stand mounting. It is mounted in a solid aluminium case and has a 3in. dial. It is sealed and cannot be damaged. It is ideal for concert tuning and easily holds the carrier wave. It is only one-third the cost of any condenser having the same range and accuracy. Use it as aerial tuning, secondary tuning or variable grid.

Price (.0001 to .001 mfd.) .. 21/-

## THE GRAHAM PATENT COIL

TABLE  
CAT. NOS.—G. COIL.—3in. DIAMETER.  
Approx. wave length in shunt w/.001 mfd.C.

Turns		Price £ s. d.
25	120-400 .....	0 2 6
30	120-450 .....	0 2 8
35	170-500 .....	0 2 10
40	190-550 .....	0 3 0
45	210-600 .....	0 3 2
50	230-700 .....	0 3 4
75	350-1100 .....	0 5 0
100	400-1200 .....	0 6 0

Prices stated above are for either 3in. or 4in. diameter coils, unmounted. Coils complete with mounting (fixed or movable) extra .. 0 6 0

## THE GRAHAM COIL (Patented)



It is a new and improved form of coil, and carries through the whole amateur wave length 200-1200 metres, giving a maximum efficiency. Owing to its peculiar construction, its distributed capacitance is reduced, internal resistance is lowered, high-frequency losses are minimised, and the self-inductance is increased. The coil answers perfectly all the requirements of the amateur who wishes to construct his own set, whether it be a loose coupler, variometer hinge coil method (primary, secondary and tickler) or sliding coil system. Any system which can be used for such coils as solenoid, honeycomb, pancake, staggered, basket-wound, spider web, pile-wound or other multi-layered coils, to vary the coupler or inductance, is applicable to the Graham Coil with the greatest of ease. A loose coupler made with the Graham Coil occupies only one-tenth of the size of an ordinary loose coupler, having the same range and wave length. The Graham Coil is made in two sizes only, 3in. and 4 in. in diameter, thus enabling a 3in. coil to slide or turn inside a 4in., and the experimenter will appreciate the advantage of this when designing his set. The coils are made up in varying widths from 1in. to 2 1/2 in. and of 3in. and 4in. diameter. The coils will fit all American and English apparatus. Table gives with a 3in. diameter coil, approximate wave length (min. to max.) when placed in shunt with .001 mfd. ordinary condenser. Table for 4in. diameter coil had not arrived from our laboratory to allow for insertion in this issue. Prices stated are for either 3in. or 4in. diameter coils, unmounted.

## GRAHAM'S GRID LEAK



THIS Grid Leak is hermetically sealed so that the resistance does not alter but the resistance can be readily altered and adjusted by the operator. It may be used as a Grid Leak or as the resistance unit in the resistance capacity method of amplification, one or more stages as required. It is finished in nickel-plated brass ebonite, and is supplied complete with clips ready for mounting on your panel in any resistance from 50,000 ohms to 5 megohms (50,000,000 ohms.) Complete with Clips. .... Price, 9/6

## RADIO FREQUENCY TRANSFORMER

GRAHAM'S R.F. TRANSFORMER for use in the tuned plate method of Radio-frequency amplification. If the feed back is put into the plate circuit instead of into the aerial, the result is that there is no radiation from your aerial when your set is oscillating in searching for carrier waves, and you thus not only gain the advantage of amplifying very weak signals or music, but you also do not interfere with any other station in your district, even if you do burst into oscillation. Sooner or later, regulations will prevent the use of Radiating circuits here, as has been done recently in England.

R.F. Transformer—200-600 metres. Price, 21/-

Complete tuning transformers R.F. built with the Patent Graham's Coils and Condenser, tunes to any wave length from 200 to 600 metres.

Complete .. Price, 42/-

This equipment is procurable from all Radio Dealers. If your dealer cannot supply, write us direct. DEALERS—We manufacture and can fulfil all your Radio Requirements.

# Continental Radio and Electric Company

165 KENT STREET, SYDNEY.

The

AUSTRALASIAN WIRELESS REVIEW

PUBLISHED MONTHLY

Vol. 1: No. 5

MAY, 1923

Price One Shilling and Sixpence

CONTENTS

<i>Editorial</i> .....	2-3	<i>The Cavite Radio Station</i> .....	26-27
<i>John Henry, the Discoverer of Radio Frequency</i> .....	4	<i>The New 1½ Volt Valve</i> .....	27
<i>Melbourne Hears Sydney Radio</i> .....	5	<i>The Association for the Development of Wireless in Australia</i> .....	27
<i>New Apparatus and Appliances</i> .....	6-7-8	<i>How to Begin, By An Amateur for Amateurs, Article 4</i> .....	28-29
<i>The Harmonic Method of Calibrating a Wave Meter</i> .....	9-10	<i>Inspiration for the Trans-Pacific Tests</i> .....	30
<i>New Tube Without "B" Battery</i> .....	10	<i>The Radio Desk</i> .....	31
<i>Radio Telephony, by "X" (Specially Contributed)</i> .....	11-12	<i>Series-Parallel Switches</i> .....	31
<i>An Operator's Story of a Prince's Surprise Party</i> .....	12	<i>The Electron</i> .....	32
<i>Wireless Pops From Everywhere</i> .....	13-14-15	<i>The Pricess Reflex Receiver</i> .....	33-34
<i>The Audion Valve, by Claude McClure, North Sydney Club</i> .....	16	<i>How to Make Fixed Condensers</i> .....	35-36
<i>The Poor Man's Valve Receiver</i> .....	17	<i>Amateur Radiophone Transmitters</i> .....	37-38-39
<i>Wonderful Crystals</i> .....	18-19	<i>Radio and Audio-Frequency</i> .....	39
<i>Trans-Atlantic Tests</i> .....	19	<i>Tips for Fans</i> .....	40
<i>Using the A.C. Mains for Receiving and Transmitting Valves</i> .....	20-21	<i>At the Sydney Royal Show—</i>	
<i>The Advantages of the Variable Grid Condenser</i> .....	21	<i>The Universal Electric Co.</i> .....	43
<i>The Crystal Detector Receiver</i> .....	22-23	<i>The Western Electric Co.'s Display</i> ..	43
<i>Major Newman's Panel Receiver</i> .....	23	(Continued on Page 45)	
<i>Mr. Raymond Cottam Allsop, An Australian Radio Engineer</i> .....	24	<i>Mark Foy's Exhibit</i> .....	45-46
		<i>The Home Electric</i> .....	47
		<i>Amateur Transmission in Melbourne</i> .....	47
		<i>Anthony Hardern &amp; Son's Enterprise</i> .....	48
		<i>Answers to Correspondents</i> .....	48

ILLUSTRATIONS

<i>The Diagram of the Harmonic Calibration Method</i> .....	9	<i>Mr. Raymond Cottam Allsop, Australian Radio Engineer</i> .....	25
<i>Telephony Modulation Circuits</i> .....	11	<i>The Arc Converter at the Cavite Radio Station</i> .....	26
<i>Mr. F. B. Miller's Receiving Set</i> .....	13	<i>The New 1½ Volt Valve</i> .....	27
<i>The Aerial at 5 B.F.</i> .....	14	<i>Series-Parallel Switches</i> .....	27
<i>Applecross Wireless Station</i> .....	15	<i>Diagrams of the Pricess Reflex Receiver</i> ..	33-34
<i>Front of Panel, The Poor Man's Valve Receiver</i> .....	17	<i>General View of the Radiophone Transmitter</i> .....	37
<i>Stages in the Creation of the Pizzo Crystals</i> .....	18	<i>The Universal Electric Co.'s Exhibit (Sydney Royal Show)</i> .....	42
<i>The Wander Crystals Under Pressure</i> .....	19	<i>Mark Foy's Exhibit (Sydney Royal Show)</i> ..	45
<i>Diagrams for Using the A.C. Mains</i> .....	20		
<i>Major Newman's Panel Receiver</i> .....	23		
<i>The Home Electric Stand (Sydney Royal Show)</i> .....	41		

The "Australasian Wireless Review" is forwarded to any address in Australasia for 15s. per annum

HERE is Character in

PRINTING

THIS Review is Printed by

W. PIERPONT BLACK & CO., 304 KENT STREET, SYDNEY

## Editorial

### STILL WAITING SPECIFIC INFORMATION ABOUT PATENTS

SINCE the April number of the "Review" went to press an advertisement has been inserted in the daily press by Amalgamated Wireless (Australia) Ltd., warning all and sundry that radio apparatus cannot be manufactured and sold without infringing the patents said to be held by that Company.

No specific information was given as to what patents would be infringed if wireless transmitting and receiving sets were put on the market, and as Section 125 of the Commonwealth Patents Act 1903-1909 provides that a patentee shall declare the day, year, and number of a patent granted in connection with any invention, it is obvious that the advertisement of the Company mentioned above does not comply with the law, and is therefore invalid as a notice of infringement.

Further, there is no provision in the Patents Act to permit any person, firm or company, to make a general statement, by advertisement or otherwise, regarding patents, but the law does require that any person infringing a patent shall be PERSONALLY notified, and no damages can be recovered by a plaintiff, "except on proof that the defendant was duly notified of the infringement, and continued AFTER SUCH NOTICE to make, use, or vend, the article so patented."

The words within inverted commas are those of the section, the capitals are ours.

In the Editorial of the April "Review," we invited anyone concerned to make full use of our columns, FREE OF CHARGE, to state what patent or patents they claimed to hold and which would be infringed by anyone manufacturing and selling radio apparatus.

In order that there should be no misunderstanding on the matter, we detailed, in the editorial quoted, the six leading elements of a receiving set and the seven leading items of a transmitting set.

We asked for definite particulars of patents affecting the sale and manufacture of receiving and transmitting sets embodying the items tabulated.

We followed up the April Editorial by writing, on March 28th, to Amalgamated Wireless (Australia) Ltd., specifically inviting that Company to make use of our columns, FREE OF CHARGE, to state what patents they claimed to hold, and we enclosed a copy of the Editorial for their information. The letter was forwarded by Registered Letter Post to the Registered Office of the Company at 97 Clarence Street, Sydney, N.S.W.

In our letter we informed the Company that if a reply was received by April 10th, it would be published in this, May, number of the "Review," or that the reply would be published in the following number of the "Review," if the reply was received after April 10th.

We are writing this Editorial on April 13th, and from March 28th to this date no reply has been received from the Company.

This is probably the most extraordinary thing that has happened in business history.

A Company, evidently anxious to protect its interests in the matter of patents, is offered publication of the particulars of its patent rights, FREE OF CHARGE, in what we may, with all modesty, claim to, be the leading wireless telegraphy and telephony journal published in Australasia, a journal which is widely circulated amongst those who are interested in wireless, either as amateurs, or as dealers in, and manufacturers of, wireless apparatus.

So far the Company has not availed itself of our generous offer, and we take the opportunity of publicly placing this fact on record, in order that the publication of this fact may be available at the proper time and in the proper place.

Surely the Company has nothing to conceal—why should it have?

If they hold valid patents covering the sale and manufacture of radio receiving and transmitting sets, made up of, at the most, seven patentable elements, why do they not take the opportunity to comply with the requirements of section 125 of the Patents Act and publish the day, year and number of each of the patents they claim to hold?

Does the Company hold radio patents which will prove valid on investigation? If so, what have they to fear by publication of the necessary details to permit investigation to be made?

As notice of infringement must, under the provisions of the Act, be given PERSONALLY to the person who is said to be infringing, anyone interested in the sale or manufacture of radio receiving and transmitting apparatus may claim the protection of the Act and may compel Amalgamated Wireless (Australia) Ltd., either to furnish the day, year and number of each patent claimed to be held by the Company, or to render themselves liable to non-suit in any action brought for infringement, by adopting the following course:— Those who intend to manufacture and sell radio receiving and transmitting sets should have a set of each kind manufactured for the express purpose of enabling the Company to point out what patent or patents would be infringed by the sale and manufacture of the specimen radio receiving or transmitting set.

When the sets are ready for inspection, a letter should be forwarded, through a solicitor, for preference, informing the Company that the sets have been made up for their inspection, and in order that the Company may state what patents would be infringed.

The letter should also state, that if no reply is received within a reasonable time, say fourteen days from the date thereof, it will be presumed that the Company holds no valid patents covering the radio sets, and that it is the intention of the person, firm, or company, forwarding the letter, to proceed with the sale and manufacture of the sets, after the expiry of the fourteen days.

It is certain that such a course would positively defeat any action for infringement.

If we may presume to advise, we would suggest that the course outlined be followed immediately in order that this patents matter be thoroughly probed.

We have our own opinion as to the outcome, but we shall see what we shall see!

## W. PIERPONT BLACK & CO.

*Publishers of*

### 'The Australasian Wireless Review'

304 KENT STREET, SYDNEY, N.S.W., AUSTRALIA

Fill in the following slip, enclose your Subscription, and mail it away WITHOUT DELAY

Name in (full) \_\_\_\_\_

Address (*Giving number of house*  
*where possible*) \_\_\_\_\_

\* I enclose herewith **15/-** (Fifteen Shillings) for ONE YEAR'S SUBSCRIPTION to "THE AUSTRALASIAN WIRELESS REVIEW." To be forwarded to me each month POST FREE.

Signature \_\_\_\_\_

To the Publishers of "THE AUSTRALASIAN WIRELESS REVIEW," 304 Kent Street, Sydney, N.S.W., Australia

## John Henry

*School Teacher; an obscure Scientist who laid the foundations for Modern Radio*



If it were not for a common darning needle, laboriously wrapped about with a wire insulated by bits of silk picked from a waste bag, as far back as 1827, by an obscure school teacher, it is not only possible but probable that radio, as we know it to-day, would be a phenomenon yet to be discovered.

It is hard for the modern experimenter to think that insulation applied to wire for electrical purposes had to be invented, and yet it was this simple invention that helped Henry to discover the nature of the oscillatory spark discharge essential in wireless.

He started teaching at the Albany Academy in 1826, where he taught the elements of arithmetic to a large class of boys. Some of the classes started at six o'clock in the mornings, and he worked so hard that it is marvellous that he found any time at all for the researches and experiments that made him a commanding figure in science.

The room he used as a laboratory was only at his disposal during vacation, and, worst handicap of all, his finances were utterly inadequate to provide what was necessary to conduct his experiments. In the little laboratory he strung up a fifth of a mile of wire, and here he developed the electro-magnet which paved the way for inventions more directly connected with radio.

He shares the honour of inventing the magnet with Sturgeon and Michael Faraday, who made experiments which ran more or less parallel with his own.

By carefully wrapping his wire in silk and winding it round an iron core, Henry developed electro-magnets which performed unusual feats when they were energized by a primary battery that contained only 2/5ths of a square foot of zinc surface and that required only half a pint of diluted sulphuric acid for its submersion.

In "Stillman's American Journal of Science" for January, 1831, he wrote as follows:—"Our new magnet weighs 21 pounds and lifts more than 35 times its own weight. It is probably, therefore, the most powerful magnet ever constructed."

By winding several layers of wire round his iron core, he produced at least a hundred times more magnetism than had Sturgeon, with a similar battery, and a single layer of wire on an electro-magnet of equal size and weight. A short time later Henry made an improved magnet for Princeton University that weighed 82½ pounds and lifted 2,300 pounds. By suddenly reversing the current through it, he astonished his pupils by causing the magnet to drop its armature and seize it again before it had fallen beyond the sphere of attraction, thus demonstrating the principle which is employed in every stroke of the neutral relay of the quadruple telegraph of to-day.

Henry was the first to note and record the oscillatory nature of the discharge from a Leyden jar, or condenser.

His darning needle, which had served as a galvanometer, he placed inside a coil of wire, through which he caused the stored energy of a condenser to flow. The needle was magnetized each time, but not in the same manner.

In 1842 he wrote, "The phenomena require us to admit the existence of a principal discharge in one direction and then several reflex actions backward and forward, each more feeble than the preceding, until equilibrium is obtained."

He had discovered radio frequency.

## Melbourne Hears Sydney Radio

ON the 2nd, 3rd, and 4th April, some interesting reception of Sydney amateur radiophones was carried out at the station of the writer.

The apparatus used was portion of the receiver described in the March issue of the "Australasian Wireless Review," being two stages of tuned radio-frequency, detector and "reflex," on April 2nd, and four stages of radio-frequency on the other two nights.

While testing out the above apparatus at 7.30 p.m. on Monday, the 2nd, 2.F.A. was heard working C.W., and his signals were audible about 6 feet from the phones. At 8.15 p.m., 2 I.X. was heard sending music, and from then until ten minutes past ten o'clock the complete transmission of this station was heard, scarcely a word being missed. With a small horn attached to one of the ear-pieces, the music was easily audible at twenty feet distance, and this in the open air! A complete list of the musical items, and of the remarks spoken were taken

By Ross A. Hull, Melbourne

down for verification purposes. On Tuesday, April 3rd, 2.I.X. was again heard, and the signals were louder than on the previous night, and on Wednesday, the 4th, 2.I. (?) was heard from about 7.35 p.m., and the music, &c., was enjoyed for over an hour. When the last-named station said "Good-night" (the second call letter of which was, unfortunately, not heard), 2.I.X. was again heard, and the signals, when tuned to maximum, were uncomfortably loud with the phones.

A number of the prominent members of the Wireless Institute were present at these receiving tests, and, not knowing the power of the transmitters, many guesses were made, as to the type of transmitter used, and what the power input was. There was a general consensus of opinion on the power matter, and it was decided that

it must be in the vicinity of half a kilowatt. (? Ed.)

The musical programme received on Wednesday, April 4th, was as follows: "Naughty Waltz," "Fox Trot," "Say It With Music," Violin and Piano, "La Serenata," "The Roseary," Waltz, Violin and Piano, "Mississippi Waltz," Waltz, "Whispering," Orchestral, "Fox Trot," Good-night. Perhaps some one in Sydney will let me know who was transmitting!

### COALMINE WIRELESS.

EXPERIMENTS in a South Staffordshire coalmine, 700 yards deep, have demonstrated that wireless communication in a mine is definitely possible.

This is of immense importance in the event of disaster cutting off large sections of a pit, as entombed men would be able to communicate their exact position to rescuers, thus saving valuable time and minimising loss of life.



## What You have been looking for

### A HIGH-GRADE WASHING MACHINE AT A PRICE WITHIN REACH OF ALL.

**CAPACITY.**—Small and Compact, yet its capacity is large. Seventy-five towels, twenty shirts, or seven sheets can be laundered at the one time.

**BOILING WHILE WASHING.**—A gas burner on a washing machine is of utmost importance, for the clothes are thoroughly cleansed and sterilised by boiling while washing, also for economical reasons, for less soap and no water-softener is needed.

**DRAIN VALVE.**—Special attention is called to the quick-acting, non-leakable drain valve.

**THE CALIFORNIA MAID WASHING MACHINE** will wash more clothes—cleaner in less time than any other make of washer.

Cuffs, collar bands, and the knees of children's play-clothes come out clean—no hand rubbing, soaking, or extra time necessary.

A WASHING MACHINE IS A NECESSITY, not a luxury, nowadays. The lack of help, pressure of time, and conservation of health have made it so.

*Australian Agents:*

**F. T. S. O'Donnell, Griffin & Co. Ltd.**

51-53 DRUITT STREET, SYDNEY.

FACTORY: Bourke Street, Waterloo, Sydney.

COUNTRY BRANCHES: Lismore and Newcastle.

### Does all Six BIG OPERATIONS OF WASHING

- 1 Heats the water  
*right in the machine*
- 2 Keeps it hot  
*as long as desired*
- 3 Washes the clothes  
*sweet and clean*
- 4 Boils, steams, sterilizes—*if you wish*
- 5 Lifts clothes out  
*automatically*
- 6 Wrings the clothes  
*from any position*

'Phone City 4546

## New Apparatus and Appliances

### THE RADIO HOMECHARGER.

TO get the best out of your set, it is necessary to keep your accumulator right up to concert pitch. No man would expect to get the best of work service from a horse if he half fed it.

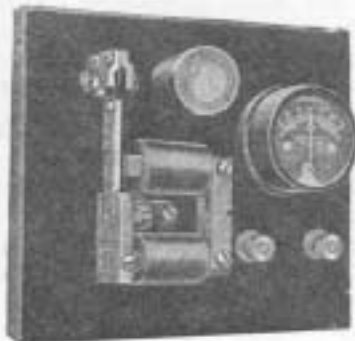

No experimenter can expect the best of work service from an accumulator unless it is "fed" consistently with the pressure mains.

The Electric Utilities Supply Co., 605 George Street, Sydney, N.S.W., have in stock the "Radio Homecharger," a practical and dependable piece

of apparatus which ensures your having the "A" Battery in the pink of condition.

The homecharger is built to last, and works day in and day out without a hitch. It is without doubt the simplest, most efficient, sturdiest and most reliable rectifier ever made. It steps down the 240 volt a.c. of the lighting circuit to the proper voltage to charge your battery, and a special rectifying valve of the magnet type ensures correct polarity supply to the positive terminal of the accumulator.

If there is any interruption of the line current the homecharger automatically disconnects itself, and resumes charging when the power is on again. As the accumulator becomes charged a gradual tapering of the charging current is automatically governed.

These features permit overnight charging with perfect safety, a boon to the keen enthusiast.

### COTO-COIL AMPLIFYING TRANSFORMER.

THE name "Coto-Coil Co." is synonymous with high-grade radio apparatus, as every well-informed fan knows. This company's goods are handled in Australasia by the same firm that represents the world-renowned Stromberg Carlson people, makers of headsets of the most super-sensitive type. Messrs. L. R. P. Bean and Co., of 229 Castlereagh Street, Sydney, N.S.W., have Coto-Coil goods now on hand, and experimenters will be furnished with all information, either in person or by post.

The Coto-Coil Audio-Frequency Amplifying Transformer maintains the manufacturers' reputation for quality. It is a shell type transformer, thereby ensuring the highest efficiency in the magnetic circuit. The ratio is 5 to 1. The primary impedance value is such as to give maximum amplification of the newer valves, as it is approximately the same value as the output impedance of the valves when under load. Each transformer is provided with four terminal lugs, which will be found very convenient for either bus or other style of wiring.

The small variation in audibility

with this transformer over a wide band of frequencies assures a minimum of distortion, making it an excellent transformer for all classes of amateur and professional work.

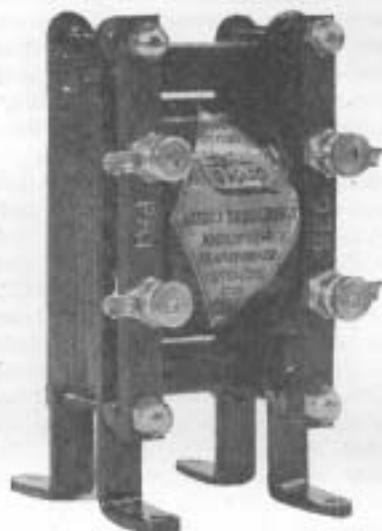

The resistance of the primary circuit is approximately 850 ohms, and of the secondary 4350 ohms at 25 degrees C.

### Consider these Prices for WIRELESS EQUIPMENT

Slide Crystal Set	-	£2 5 0
Phones 4000 ohms	-	1 10 0
Variometer, mounted	-	2 10 0
American Boy Radiophone Receiver	-	10 6
Cardboard Cylinders	-	4
Honeycomb Coils, from	-	3 6

And all other material for the experimenter.

We Stock All Parts

J. J. Hoelle & Co.

57 GOULBURN STREET

Factory: 49 Alma Street, Darlinghurst

### Wireless Course for Amateurs

£5 5s.

You may learn in your own home the technicalities of this interesting course.

If you desire to become a Wireless Operator secure particulars of our ENGINEER-OPERATORS' COURSE.

The boom in Wireless is coming—Get ready.

STOTT'S TECHNICAL  
CORRESPONDENCE  
COLLEGE

100 Russell St., Melbourne,  
70 Pitt St., Sydney,  
452 Queen St., Brisbane.



**THE GRAHAM PATENT VARIABLE CONDENSER.**

THE Graham Patent Variable Condenser is made at the works of the Continental Radio Company at Pitt Street, Sydney, N.S.W., whose head office is at 165 Kent Street, Sydney.

In this condenser there are no moving vanes, no washers, and nothing to get out of order. It is a revolution in condenser construction, and may be used in any position in the receiving set. Its range is from .0001 mfd. to

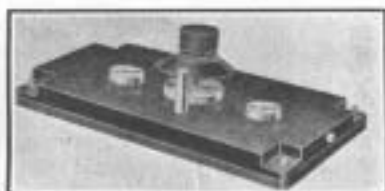

.001, and it is effective, therefore, as the aerial circuit condenser, as a grid condenser, or as a bridging condenser. It is tested to 2000 volts and gives a micrometer action throughout the whole range.

It can be mounted in either the horizontal or vertical position, and it is so compact that it is but a fraction of the size of the ordinary (and often crude) 43 plate condenser of the same maximum mfd. capacity.

Another Graham Patent manufactured by this Company is the Fluted Cellular Inductance Coil. Owing to the peculiar cellular fluted construction, distributed capacitance is reduced, high frequency losses are minimised, internal resistance is lowered and self-inductance increased. By its use, the experimenter is able to make the most of a weak signal, and to get a clearer and louder note. The coil is made in sizes ranging from 25 turns to 100 turns, covering from 130 to 1200 metres. Special adaptors are supplied to make up the three-coil mountings.

A grid leak, variable from 50,000 ohms to 5 megohms, and a special and very efficient radio-frequency transformer are amongst the various specialities handled by the Company. A full stock of headphones, loud speakers, rheostats, and all that is necessary to make up all kinds of wireless sets awaits inspection at 165 Kent Street, and amateurs should make a point of seeing the Continental Radio Co.'s goods before deciding what to buy.

**ERICSSON HEAD RECEIVERS.**

IN the British Isles the name Ericsson has become a household word, during the 25 years this firm has had its goods before the public. The Ericsson Head Receivers are robust, reliable, and they fit the head comfortably.

It is worthy of note that in 1909 the British Admiralty adopted Ericsson wireless 'phones as standard equipment, and, in 1917, the Air Board did the same thing. Needless to say, this means that the 'phones must have passed the most rigorous of tests, and that they came through these tests triumphantly.

The Company's manufacturing routine includes a searching test on every part made, and again this test is applied when the article is assembled. Nothing is left to chance. One faulty piece of apparatus would spoil a splendid reputation which has taken years to build up, and the Ericsson Co. cannot afford to take any risks, they prize their reputation too much to do so. The wireless experimenter can therefore depend upon Ericsson apparatus to be right up to concert pitch for the purpose for which it is intended, and in the Ericsson headphones he will have an article of the highest grade at a moderate price.

**MISCO.**

THE word "Misco" is made up from the initial letters of the name of the firm handling the goods sold under that trade mark, with the word "Co" added. The Mica and Insulating Supplies Co., as its name indicates, specialises in everything for efficient insulation in wireless apparatus, and in general electrical goods. The list includes Bakelite sheet in various thicknesses, and that commodity is too well-known to require any special recommendation by us; Empire Cloth and Empire Silk, two articles well known to electrical experimenters, as being of high insulating quality; Fibre in sheet, rod and tube; Mica, Micanite, and Micanite tubes; Press Spahn is another widely used insulator; Condenser Paper; Tinfoil; Ebonite in sheet and rod, and last, but not least, Irvington's Insulating Varnish. The firm's address is 56 William Street, Melbourne, and inquiries re insulating materials will receive prompt attention.

Get All

**RADIO SUPPLIES**

at

**ELECTRICITY HOUSE**

- Complete Valve Sets, from £12 0 0.
- Complete Crystal Sets, from £3 10 0.
- Knobs and Dials, Polished Ebonite, 5/6.
- Aluminium Dials, 1/6.
- Knobs, 1/-, 1/6, 2/6.
- Studs, 1/9 doz., with Nuts.
- Condenser Plates, 1/9 doz.
- Spindles, 2/9 set.
- 'Phone Condensers, .001, 1/6.
- Terminals, 6d. each.
- Grid Condensers, .0005, 1/6.
- Murdoch's 'Phones, 30/-, 2000 ohms.
- Murdoch's 'Phones, 40/-, 3000 ohms.
- Brown's 'Phones, 25/-, 150 ohms.
- Brown's 'Phones, £5 3 6, 2000 ohms, Adjustable Diaphragm.
- A.T.M. 'Phones, £3 10 0, 2000 ohms.
- Myers' Valves, 37/-; R4, 37/6; Radiotron, 37/6.
- Crystal Cups, 1/-.
- Detectors, 5/6.
- Catalogues containing 50 Wiring Diagrams, 9d. ea.
- Audio Transformers, 40/-.
- And all other Gear not enumerated.

387 George St., Sydney

Tel. City 2961

**THE DE FOREST INTERPANEL TUNER.**

THE panel of this tuner is 12½ inches wide by 9 inches high. The primary condenser has a capacity of .0015 mfd., and the secondary is one of .001 mfd.

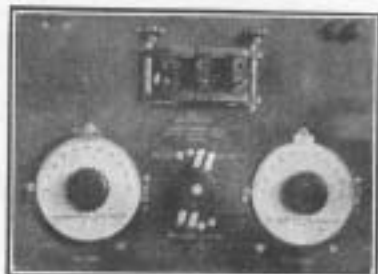

Both of these condensers are of the vernier type, a single movable plate being controlled by the handle projecting beyond the celluloid scale attached to the main group of moving plates. Between the condensers and below the coil mounting is the shunt-series switch that connects the primary condenser in either shunt or series with respect to the primary honeycomb.

The De Forest apparatus is in stock at the Burgin Electric Co., 352 Kent Street, Sydney.

**THE DURHAM VARIABLE HIGH RESISTANCE.**

THIS is a patented high resistance which can be varied to suit the grid leak requirements of any receiving or transmitting set. It is made in two sizes, one ranging from 1,000



to 100,000 ohms and the other with a range of 100,000 to 5 megohms.

The variation is brought about by pulling out or inserting the plunger

TELEPHONE CITY 8843

ALL WIRELESS SUPPLIES  
FROM

**MISS F. V. WALLACE**  
ELECTRICAL ENGINEER

8 ROYAL ARCADE  
OFF. QUEEN VICTORIA BUILDING  
GEORGE STREET  
SYDNEY

so that the variation may be done from the front of the panel when conducting experiments. Incidentally it is the ideal thing for the Armstrong-Super-Regenerative Circuit, as the 12,000 ohms resistance required is easily obtained with the No. 100 Durham Variable.

It is manufactured by Durham & Company, Radio Engineers, 936 Market Street, Philadelphia, U.S.A.

**THE NEW ALKUM STORAGE BATTERY.**

THE Alkum Storage Battery is a new British product of the nickel-iron type with insoluble electrodes and unvariable Alkaline Electrolyte. New methods of manufacture never attempted before have been invented and new machinery for the manufacture of the battery has been made and per-



fect and now an Electrical Accumulator has been produced that is unsurpassed by any type of accumulator.

The outside container as well as the plates are made of nickelled steel in a rigid construction. This solidity of construction throughout the Alkum Accumulator gives the best guarantee for great durability and mechanical efficiency, so that when subject to violent jolting, as when used in a motor car, the cell will not be injured.

Five and seven hours are given as the normal charging times, but the rugged nature of the construction permits the charge to be put in in half the time on emergency.

It is the ideal cell for wireless telephony and telegraphy purposes as it will deliver the full current at which it is rated for the full number of hours discharge.

The Alkum Accumulator is handled in Sydney, N.S.W. by Messrs. F. T. S. O'Donnell, Griffin and Co. Ltd., of 51 Druitt Street.

**Stromberg-Carlson**  
No. 2a  
**RADIO HEADSET**

A HIGH-GRADE Headset of correct design built by a firm with 28 years experience in telephone manufacture.

Your Headset is the most important item of your set and as telephone engineers, we earnestly recommend you



to buy the best, particularly when the price is but half that demanded for other high-grade sets on the market. Coils are layer wound, each layer being extra insulated from the next.

*Supersensitive to either vocal or musical sounds—Durable—Comfortable—Maximum efficiency*

Ask your dealer or write us direct

Also  
Radio Plugs and Jacks  
Radio Microphones  
Cotoco Inductance Units  
Radio & Audio Transformers  
Variable Condensers, &c.

Australian Representatives:  
**L. P. R. BEAN & CO.**  
LTD.

229 Castlereagh St., Sydney  
Adelaide: CHAS. ATKINS & CO. LTD.  
Perth: T. MUIR & CO., 99 William St.  
Brisbane: S. H. SMITH Ltd, Radio House  
299 Adelaide Street

# The Harmonic Method of Calibrating a Wave Length

By RAYMOND COTTAM ALLSOP.

THE writer has found the following scheme an extremely useful one as an aid in calibrating a wave meter.

The scheme makes use of the fact that a non-sinusoidal current is resolvable into a fundamental, and a series of harmonics, at the frequencies of the fundamental.

If the frequency or the wave length of any one of the series of harmonics, including the fundamental, is known, then the frequency or wave length of each of the other members of the harmonic series is accurately determined.

The scheme may be useful in checking the accuracy of a wave meter already calibrated, or the

although, as a rule, the oscillations are very closely sinusoidal in form. Strong harmonics may be produced by the addition of Circuit 2.

Circuit 2 consists of a rectifier valve, R.2., which is in series with the coils, L.2., L'.2., and a portion of L.1. The rectifier may be an Audion with the plate and grid connected.

L.1. is a coil of 50 to 100 turns. L'.2. is a coil of a few turns.

Circuit 2 may be inductively coupled to L.1. instead of being directly connected as shown in the diagram.

The current through L.2. consists of a series of impulses corresponding approximately to the recti-

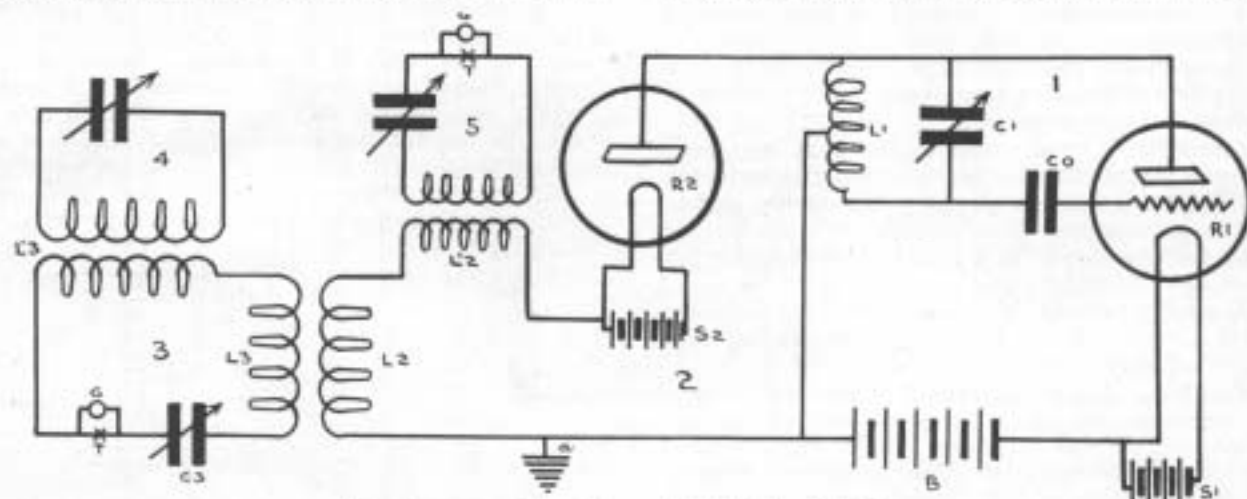

The Diagram of the Harmonic Calibration Method.

method may be of service in extending the calibration either above or below the wave lengths for which it has been calibrated, if a certain small range of an octave of the calibration has been already made by some other method.

The method is as follows:—Continuous oscillations are excited in Circuit 1 of the diagram, herewith, by means of an Audion Pierce Mercury Bulb, or other form of electron relay, using any one of the familiar connections. A radio-frequency alternator would also serve as a source of continuous oscillations.

The connections used by the writer are shown in the diagram where L.1. is a single layer solenoid provided with a tap at its centre point. C.1. is a variable air condenser, forming with L.1., the oscillatory circuit, 1. R.1. is the electron relay. C.2. is the stopping condenser. B. is a high voltage battery which supplies the energy for the oscillations. S.1. is the filament battery for the electron relay.

The oscillations in Circuit 1 may, under certain conditions, show the presence of weak harmonics,

defined pulses obtained if all the half loops of the waves in one direction of the current in Circuit 1 are suppressed. Because of the non-linear resistance characteristic of the rectifier, the pulses are not sinusoidal in form.

Whatever their shape, the current in L.2. may be expressed by Fourier's series of the form.

A third circuit, 3., consisting of inductances L.3. and L'.3., a variable air condenser, C.3., and the thermocouple T., shunted by a galvanometer G., is loosely coupled to Circuit 2.

Circuit 2. can be tuned to any of the harmonics of the circuit to L.2. The tuning is exceedingly sharp, and should be done by means of a micrometer attachment on the condenser, or by a long ebonite handle attached to the moving element of the condenser.

The thermocouple T. consists of a one mil. (0.001 inch=0.025m.m.) platinum wire rolled flat and fused at one corner to a small piece of tellurium. Its resistance is about 2 ohms.

G. is a Leeds and Northrup's 5. ohms galvanometer.

A fourth oscillatory circuit, numbered 4, in the diagram, represents the wave meter under test, and is shown loosely coupled to Circuit 3, through the inductance L'3.

When Circuit 3 is tuned to any of the harmonics of the circuit in L.2., the galvanometer shows a deflection. If the wave meter circuit is now tuned so that it has the same natural period as Circuit 3., the galvanometer deflection decreases because of the absorption of energy from Circuit 3., and, therefore, the same indication of the thermocouple and galvanometer serves to indicate when Circuit 3. is tuned to one of the harmonics, and when Circuit 4. is in resonance with Circuit 3.

To calibrate the wave meter, condenser C.1. is so adjusted that either the fundamental or one of the harmonics falls within the previously calibrated range of the wave meter. Condenser 3. is then varied until Circuit 3. is tuned for the fundamental, as will be shown when the deflection of the galvanometer is at maximum. Circuit 4. is then tuned to Circuit 3.

Resonance is indicated by a decrease of the galvanometer deflection to a minimum. The reading of the wave meter is observed.

Circuit 3. is then tuned to the next harmonic, which has double the frequency of the fundamental, and Circuit 4. is again adjusted to reduce the deflection to a minimum. This process is repeated for several harmonics, or for all that are sufficiently intense to be of use.

The adjustment of the condensers for resonance in both Circuits 3. and 4. is very easily made, with a deviation of less than 0.1 degree in 180.

Point A. in the diagram is grounded to prevent resonance of coil L.2. when excited by the fluctuations in potential of the middle point of L.1., to which L.2. is connected. This precaution ensures that the excitation of L.1. comes through the rectifier only. Even with this precaution, L.2. may oscillate if the natural period of the coil approximates the period of one of the harmonics of the impulses which pass through the rectifier.

The resonance for one harmonic is undesirable, because of the resulting magnification of the cor-

responding amplitude in Circuit 3., this great difference in amplitude causing inconvenience, as the widely different galvanometer deflections may produce slight inaccuracies in the data, due to the differing degrees of reaction on the oscillations of Circuit 1.

The oscillations of coil L.2. are eliminated and properly proportioned.

Amplitudes of the harmonics of the series are obtained by winding coil L.2. with about 100 turns of fine high resistance wire.

This added resistance is small compared with the resistance of the Audion rectifier, and consequently does little harm.

Unless the absorption of energy by Circuit 3. is considerable, no change in the frequency of the oscillations can be detected.

Full scale deflections of the galvanometer are obtained with no harmful results on the fundamental oscillations.

In case there is any doubt as to the constancy of the frequency of Circuit 1. while Circuit 3. is tuned to the series of harmonics, it is advisable to loosely couple to Circuit 2, through L'2, a control circuit, numbered 5 on the diagram, which may be tuned to the fundamental and used to detect any slight change in frequency.

A typical series of harmonics and the corresponding galvanometer deflections are given in the following table:—

HARMONICS.	DEFLECTIONS.
1.	72
2.	66.
3.	12.
4.	11.
5.	3.6.
6.	2.2.
7.	0.8.

This scheme was used by the writer in calibrating a wave meter having a range of from 100 to 10,000 metres. A part of the scale, from 500 to 1,000 metres was calibrated by the rotating mirror method. The accuracy of this calibration was checked, and the calibration extended, in both directions, to cover the entire range of the instrument.

**A** NEW type of detector tube has been perfected in the laboratories of the University of Illinois, Urbana, Ill. The tubes have been filed with the Patents Office in Washington, and application made for patents. They are the result of research and development work by H. A. Brown and Dr. C. T. Knipp, of the University.

The new tube is very efficient and as it does not require a high plate voltage or filament temperature, it should be economical in operation.

Certain alloys or rare elements are introduced into the new tube, where

#### NEW TUBE OPERATES WITHOUT "B" BATTERY.

they form a vapor. This causes the tube to function as a photoelectric cell; that is, current flows from plate to filament without the need of a plate or "B" battery when the tube is illuminated by the filament, or by some other source of light.

It is found that these tubes are sensitive detectors at any applied plate voltage from zero to 30 or 40 volts. They are most sensitive at 10 volts.

Using one of these tubes as a detector in a variometer type of short wave regenerative receiver, the broadcasting stations at Schenectady, N.Y., Detroit, Pittsburgh, Chicago, and Kansas City, can be clearly heard in Urbana without any amplifier, and with zero plate voltage.

In the above mentioned cases the plate circuit return is connected to the negative filament terminal so that the plate current at zero plate voltage is not caused by filament potential drop; it flows in opposition to this potential.

# Radio Telephony

By "X."

**D**IRECT modulation is the simplest and cheapest of all methods, and is very suitable for short-range transmission. Speech is very clear and a range of 5 miles can be easily attained with a three valve receiver used as a transmitter. All that it is necessary to do is to connect a microphone directly in the aerial lead of the receiving circuit at a point of low potential to earth, that is between the aerial tuning inductance and the earth proper, and to make the valve receiver oscillate as strongly as possible

The power that may be used is limited by the volume of power the microphone can control.

The method of semi-direct modulation is an improvement on direct modulation. In this case the volume of power absorbed from the aerial circuit into the modulation circuit is controlled by the microphone, and, therefore the oscillations on the aerial are damped in time with the microphone variations. Speech is extremely clear, but the microphone is alive and power is limited by the

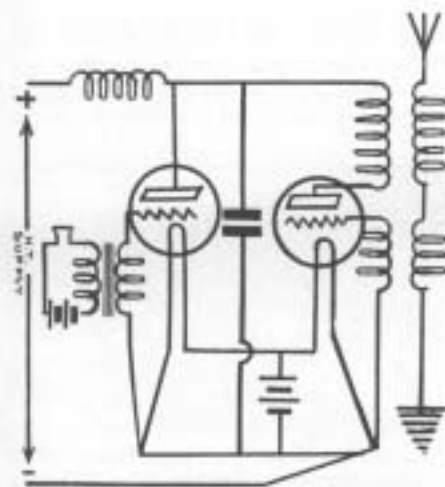

FIG. 1.

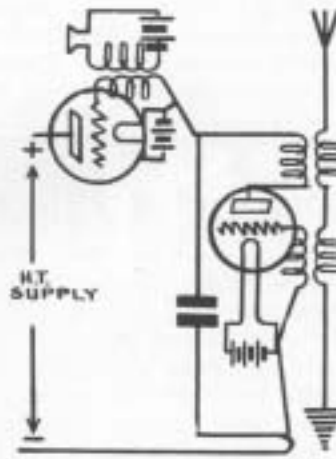

FIG. 2.

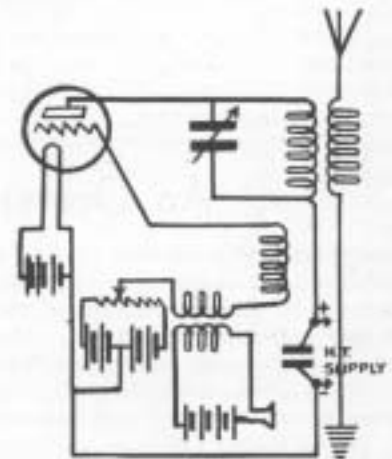

FIG. 3.

Fig. 1. A Plate Modulation Circuit.

Fig. 2. An Alternative Plate Modulation Circuit.

Fig. 3. A Grid Modulation Circuit.

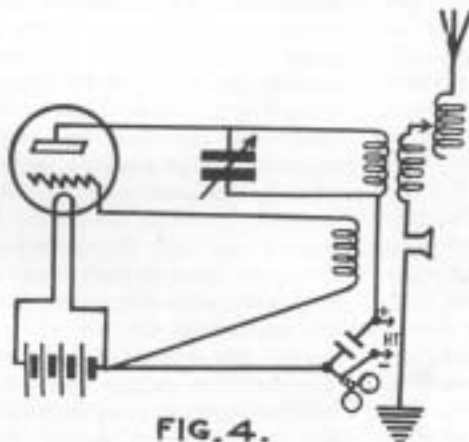

FIG. 5.

Fig. 5. A Semi-Direct Modulation Circuit.

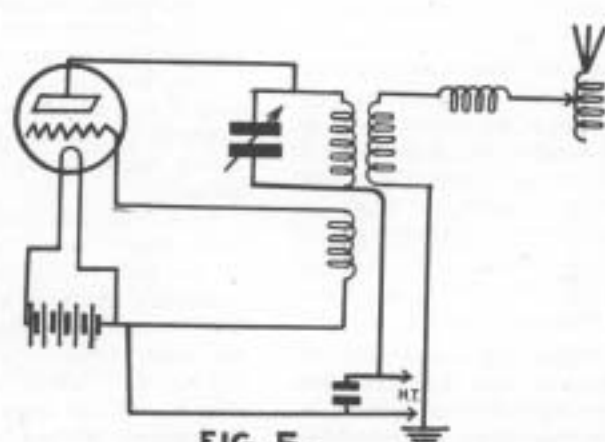

FIG. 4.

Fig. 4. The Direct Modulation Circuit.

sible on the aerial. Care must be taken to insulate the microphone from earth.

In the direct modulation circuit, the amplitude of the oscillations set up in the aerial circuit is varied by the resistance of the microphone being varied in time with the sound waves.

volume of power that can be controlled by the microphone.

Semi-direct modulation is a method which is an improvement on direct modulation. In this method, the volume of power absorbed from the aerial circuit into the modulation circuit is controlled by the

microphone, and, therefore, the oscillations in the aerial are damped in time with the microphone variations. Speech is extremely clear, but the microphone is alive and the power used is limited to the volume that can be controlled by the microphone.

When distortion is present, either in transmitting or receiving telephony, the cause is traceable to some fault in the apparatus.

There may be inertia of the diaphragms in the microphone or telephones, due to diaphragms which are too heavy to respond easily.

An excess of inductance in the modulation device may cause the voice to become "drummy," the excess induction resulting in a smoothing-out effect of the overtones.

The voice may be rendered squeaky by an excess of capacity in the modulation device.

The presence of iron cores in either the transmitting or receiving circuits, owing to the hysteresis effect of the iron, may interfere with the uniformity of the transformation.

I have now dealt with four methods of modulation:—

- Plate modulation.
- Grid modulation.
- Direct modulation.
- Semi-direct modulation.

Herewith are diagrams showing the connections of the different modulation methods.

Figure 1 gives the connections for a plate modulation circuit the method usually adopted for long-distance transmission with high power.

Figure 2 is an alternative method of plate modulation. In this circuit the power is limited to the volume which can be passed by the modulator valve.

Figure 3 is the circuit diagram of the grid modulation method, in which the steady potential of the grid of the oscillation valve is varied by the microphone.

Figure 4 is a direct modulation circuit, an excellent method for short-range transmission.

Figure 5 is a semi-direct modulation circuit, a method which is an improvement on direct modulation.

## An Operator's Story of a Prince's Surprise Party

THE announcement that Dr. Lee de Forest, of Audio fame, has constructed a musical instrument from audion valves, and operated by a keyboard, like a piano, has brought forth a story from a commercial radio operator of a Prince's surprise party.

Every radio fan knows the beautiful whistles and howls a valve is capable of producing, and will readily understand the principles underlying the construction of a valve piano.

Whether Dr. Lee de Forest was the first to construct this type of musical instrument or not, is beside the question, the fact is on record that the Prince of Monaco (the principality in which the famous Monte Carlo gaming saloon is situated, and which, by the way, furnishes the greater part of the Prince's income), had a spark piano several years ago.

This is the story:—

Long before the advent of the present popular radio telephone, back in the days when the only radio amateurs were the chaps who mastered the International Morse code, and little dreamed of ever being able to hear anything over the radio waves except the dots and dashes that spelled out the messages letter by letter, a mysterious steam yacht glided slowly one night into New York harbour, up past the skyscrapers of

Manhattan to an anchorage up in the Hudson River opposite Riverside Drive, where she dropped anchor and hoisted her riding light.

No shore-going party left her side in the little gasoline tender. Her distinguished owner had business aboard that night; he had a little surprise to spring upon America—a surprise which no one but a man of much wealth could afford to spring. It had taken time and money and plenty of genius and imagination to prepare this surprise party.

I was listening-in myself that night. Soon I and my fellow amateurs were listening to something I had never before heard—music by radio telegraph!

First came the "Star-Spangled Banner"; then "Yankee Doodle," followed by the "Blue Danube Waltz" and other selections. The word spread like wild-fire. Station called station and passed the word, "Listen-in for the music on 550 metres." Ships at sea heard it, stations up and down the coast and the amateur stations back inland were getting it. Whence came the music and how was it played?

It was not until twenty-four hours later, when the press announced the arrival of the Prince of Monaco on his yacht the "Hirondel" and told of his marvellous new "wireless invention" that anyone knew.

The visitor was none other than the Prince himself. He had voyaged all the way to America from his palace on the shores of the Mediterranean for the express purpose of springing his surprise on America.

How did he do it? It was a clever arrangement. Anyone who has ever listened-in to the radio stations transmitting messages by the spark system will recall that each station has its characteristic note, the musical pitch of which is governed by the adjustment of the apparatus in use. The Prince had arranged his radio transmitter with a set of piano keys so that each individual key, when depressed, would transmit a spark signal at a certain adjustment for pitch; by properly adjusting the device for frequency and pitch he had produced a complete musical scale, and it was then only necessary for him to play the instrument just as one plays a piano. For variety, he would pause now and then on one particular note, and by depressing and releasing that key at intervals he transmitted a few words of jest in code, after which he would continue the air he had started to play.

When the Prince up-anchored and sailed away he did so with the satisfaction of having accomplished his mission.

## Wireless Pars from Everywhere

### THE TELEPHONE WIRE AS AN AERIAL.

A CORRESPONDENT has successfully used the telephone wire as an aerial. The aerial terminal of the set was connected to the telephone, and the usual earth connection was used. It is stated that as good results were obtained as with a 150 feet outside aerial.

### TWO-WAY TELEPHONY.

MR. CHAS. MACLURCAN, of Sydney, and Mr. Cureton, of the Burwood Radio Club, Sydney, have been carrying out some interesting tests in two-way telephony. By tuning each receiver to receive the transmission of the other station, and using the word "over" as a change-over signal, a continuous conversation was carried on practically as easily as over a land line telephone.

### ON SUNDAY MORNINGS.

NOW that the amateur transmitters are busy in the Sydney district, the Editor's life promises to be a happy one, for he can get topical reports via the ether by listening in and talking down test reports in shorthand. For instance, last Sunday morning, Burwood was testing with 2.B.B., and the following was heard: "Get a piece of paper and take down our report, which is a little lengthy." After a pause came, "Ready. Your No. 1 microphone was good and clear. Your No. 2 was clear and much like No. 1. No. 2 with loose coupling sounded very good. No. 3 was really the best of all, and it was louder. It was breaking slightly at times, but it got better after you said to wait a minute. Then you said, 'I will go back to No. 2, I will have to alter the tuning,' after which No. 2 was good, but it was still not as good as No. 3. When you went back to No. 3 at the point where you said to 'wait a minute,' and afterwards, 'I don't think this is up to much,' it was clear, not a bit husky and it was loud. No. 2 with loose coupling was very good, too. Will you let us know if you got this all right after a second or so to allow us to cut off the generator."

Sunday mornings will become red letter periods for the fan eager to receive telephony.

### PHOTOS BY WIRELESS.

A GREAT improvement in the method of transmitting photographs by wireless is announced by the "Daily Mail." Since 1908, Mr. T. Thorne Baker, a pioneer worker in radio-photography, has been experimenting with the end in view of perfecting photo transmission. Full details are not yet available, but it is stated that his improvements have revolutionised photo-transmission by wireless.

### WIRELESS IN MINES.

FURTHER experiments have been conducted in America by the U.S.A. Bureau of Mines in conjunction with the Westinghouse Co. in order to gauge the suitability of wireless communication for rescue work. Two hundred metres C.W. was used, and signals were distinctly heard through 50 feet of coal strata. Single turn loop aerials were found to be the most efficient, and the results were considered to justify further experiments.

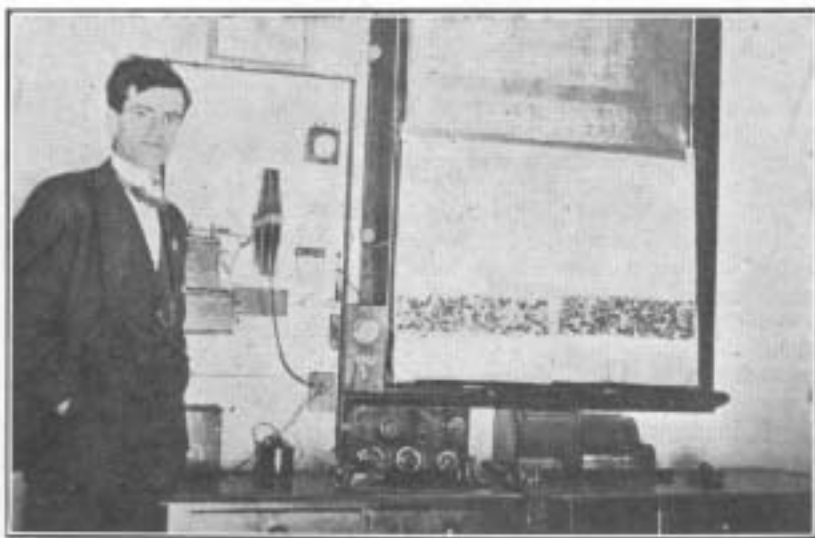

Mr. F. E. Miller, of Murray Bridge, South Australia, and his Receiving Set

### ESPERANTO SONG BROADCASTED BY RADIO.

IN the words of the announcer of the London Broadcasting Station, "an item of rather unusual interest" was included in its Radio Concert on Friday evening, the 8th December. Miss Gladys Cosmetto sang "Until" in the international language, Esperanto.

Although speeches in Esperanto have already been broadcasted in the United States, this is believed to be the first occasion on which a song has been rendered in the international language.

This was in connection with a lecture and demonstration of radio reception by Mr. H. K. Epton, Chairman of the Hackney and District Radio Society, at the London Esperanto Club, St. Bride's Institute, Ludgate Circus, E.C.

### WIRELESS IN SCHOOLS.

WIRELESS is the latest craze at our public schools, and all the headmasters are not disposed to regard it wholly as a boon and a blessing. Merchant Taylors' school contemplates a wireless installation, and Dr. Nairn is a little apprehensive lest this new form of communication should prove so attractive in its novelty to parents as to turn the school into an inquiry bureau.

He dreads mostly those parents who have shunned the telephone, but who are likely to make wireless an obsession. Dr. Nairn humorously suggests some such inquiries or instructions as "Did Jack take his handkerchief to school?" and "Please take care of Dick's vaccination arm."

"On these occasions," he observes, "I shall not be found listening-in."

## PLACING WINGHAM ON THE MAP.

THE town of Wingham, 228 miles from Sydney on the West Maitland-Macksville line, is to be congratulated on having a real live Mayor, who is making enquiries into the possibilities of radio service for the people in the back country, inland from the Wingham township. The telegraphic information states that the inquiries are in the direction of installing, receiving and distributing wireless plant, which we can understand to mean that the Mayor's idea is to have a powerful receiving set at Wingham to receive Sydney radio concerts and then to re-transmit them to the people in the country surrounding Wingham.

If this idea is carried into effect, Wingham will surely be placed on the map in a most novel manner. In the February number of the "Review" (Editorial), we made the suggestion that country towns and the districts surrounding them should be served by radio in the manner now being inquired into by Wingham's Mayor, and we congratulate him on his initiative and enterprise in moving in the matter of bringing radio service to the people of the Wingham district.

If there are other live Mayors in other country towns, we will be pleased to help them by giving them such information as they may desire concerning the particulars of the apparatus necessary, for receiving and re-broadcasting radio concert brought into the country towns from the larger cities.

## STRONGER SIGNALS.

MR. E. W. BONWILL, of Cowra, writes in to say that while experimenting with his set, he found that by placing a .0005 fixed condenser across the secondary terminals of the last amplifying transformer, the strength of signals was increased by at least 30 per cent., and stations that came in very weak are now brought in with quite strong signals. He sends in this information in order to give other experimenters the opportunity of testing the experiment for themselves. This is the true spirit of camaraderie, which we would like to see more freely displayed by Australasian amateurs. Most experimenters hit upon some little kink that others would like to try out. Why not send those little kinks along?

## A HOME-MADE BROADCASTING SET.

IN the first number of the "Review," January, 1923, an article was published under the above heading, which gave full details for constructing a set having two stages of audio-frequency.

Mr. Francis, of Ramsay, Sharp & Co., Sydney, now informs us that he has made up sets according to the article mentioned, and that they have proved highly successful. Have other amateurs tried out this circuit?

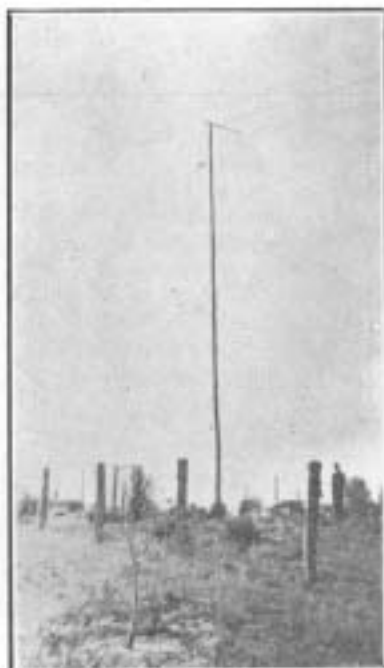

The Aerial at 5 B.F. (Mr. F. E. Miller)

## DOCTOR WIRELESS.

THE cables recently brought the news that a fireman on board an ocean liner, tried to appease his thirst by putting his tongue on one of the pipes in a refrigerating chamber. It is an experience he is not likely to repeat, as his tongue became frozen to the pipe. His cries for help brought assistance, and the refrigerating machinery had to be shut off and hot air put through the refrigerator pipe before he could be released. By that time the man was in a very bad state, and as there was no doctor on board, the captain of the vessel wirelessed for medical instructions to treat the patient. The necessary directions were given by a doctor through the ether, and after two weeks the fireman was able to return to duty.

## WHO WILL BE THE FIRST AUSTRALIAN AMATEUR TO BRING IN AN AMERICAN BROADCASTING STATION CONCERT?

THE postmaster at Wailuku, Hawaii, recently heard the broadcasted concert of the Detroit (U.S.A.) "News." The distance covered was 4,400 miles, and this without any special effort or arrangement of valves. A school-teacher, J. E. Samuels by name, in Wales, Great Britain heard the City Symphony Concert at the Century Theatre, New York, U.S.A., and clearly heard the applause that followed the numbers on the programme. The distance, in this case, was 3000 miles. An employee of the Burndept Co., London (England) heard the Newark (U.S.A.) broadcasting stations sending out concerts, and a number of amateurs, amongst them one in Chicago, the distance in the latter case, was over 4,500 miles. The receiver was a Burndept production, having two stages of radio and two stages of audio-frequency amplification. One stage of radio-frequency amplification was added. Honeycomb coils were used, and the Chicago amateur was sending on 200 metres. This places the efficiency of honeycomb coils on short wave lengths beyond question. It should not be insurmountable to bring American broadcasted concert another thousand miles or so to Australia. What about it, Australian amateurs?

## AUTOMATIC TRANSMISSION OF WIRELESS.

AN achievement in the history of wireless communication has been placed to the credit of the Marconi International Marine Co., Ltd., and the giant White Star liner "Majestic," which arrived at New York on Tuesday. On approaching New York the "Majestic" cleared its Marconigrams to the Chatham (Mass.) wireless station with high-speed automatic transmitting apparatus, this being the first time that automatic wireless transmission has been used from a liner. This innovation was made because of the large number of business and private messages which passengers on Transatlantic liners desire to send when they are approaching the coast of America. Hitherto only hand transmission has been used by wireless apparatus at



sea, but the amount of traffic has recently grown so enormously on the "Majestic" that it has been found necessary to introduce automatic working. The "Majestic" is the first liner to be fitted in this way, and if the Marconi traffic on other transatlantic liners increases to the extent it has done on the "Majestic," it is probable that they also will be fitted with automatic transmitters. The maximum speed of the automatic apparatus used is 240 words per minute.

**DANCE MUSIC BROUGHT 1000 MILES WITH A LOOP AERIAL.**

A RADIO fan in New York gave a dance at his home in New York for which the music was supplied by an orchestra playing in Chicago. The music is reported to have come in consistently loud for two hours, without the "fading," which often manifests itself in long-distance reception. No outside aerial was used, but just a three-foot loop aerial.

**NOT FORGOTTEN.**

DAME NELLIE MELBA is proud of the fact that, on the invitation of "The Daily Mail," she inaugurated the broadcasting era two years ago by singing to all England from Chelmsford, in Essex.

"I still get letters from people with regard to that first trill which I sang into the wireless telephone," she told a "Daily Mail" reporter recently. "Only recently I had a letter from a limbless Australian soldier who heard it while in England."

**AMERICAN SIGNALS.**

THERE seems to be a perfect epidemic of Trans-Atlantic reception.

Mr. J. Samuel, of Aberystwyth, has picked up American carols on an aerial 40 feet long and only 30 feet high; and Mr. T. B. Trott, of Plymouth, writes in to say that on the morning of December 23rd, using five valves, he heard Newark's programme. But to cap it all Captain Round, of the Marconi Co., picked up an American concert on a 2-foot frame aerial, using eight valves, and received such strong signals that they were audible on a loud speaker, and woke one of his children up in the next room! We are getting on!

**THE MEN IN THE BACK BLOCKS.**

TIMBER workers in the American forests far removed from civilisation have given up cards, fights, and drunken orgies, and either possess their own receiving sets to bring in broadcasted concert from the various stations, or they assemble in halls built for the purpose by the big timber companies, to hear radio concerts brought in on apparatus also provided by the companies, which apparatus includes loud speakers. Instead of frittering away their time in the evenings in degrading "amusements," they listen to instructive talks, lectures, songs and music.

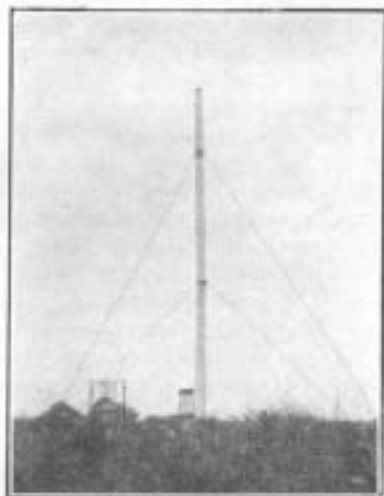

Applecross Wireless Station near Perth, W.A. Note the Direction Finding Aerial

**A KEEN EXPERIMENTER GETS HIS TRANSMITTING LICENSE.**

MR. R. C. MARSDEN, President of the Metropolitan Radio Club, Sydney, has obtained his transmitting license, and will be ready for sending about the beginning of April, on a 420-metre wave length with a power input of 10 watts. One night a week is to be devoted to general testing of telephony and C. W. Mr. Marsden intends to conduct some exhaustive tests, with various types of sound collectors, and transmitting microphones, with the object of ascertaining the best method of placing sound collectors in relation to musical instruments varying in pitch, and with regard to male and female voices, so that, incidentally, experimenters may hear quite a lot of good music from time to time, on which they should report to the popular President of the Metro. Club.

**RADIO SPREADS MARKET REPORTS OVER UNITED STATES.**

THERE are now 51 Governmental and private radio telephone stations sending out the national crop and market reports of the Dept. of Agriculture, so that the country's territory is being more and more thoroughly covered. There are awaiting approval 29 applications in several states for broadcasting the reports, and it will not be long before every farmer in the country will be able to get his reports by radio on even the most simple sets. The Bureau of Markets has official market report stations at Boston, New York, Philadelphia, Pittsburgh, Cincinnati, Chicago, Minneapolis, St. Louis, Kansas City, and Omaha, as well as 73 branch offices in 46 large market centres, 16 of which are connected to Washington by a direct wire. With these stations some 15,000 individuals, firms and railroads co-operate in gathering data on fruits, vegetables, grain and live stock. Besides the daily telephone broadcast crop reports, the Bureau of Markets also sends out reports in code through the Navy stations at Arlington and at the Great Lakes Training Station.

**RADIO CONCERT RECEIVED OVER 1000 MILES ON A CRYSTAL.**

A FARMER of Huntsville, Missouri, U.S.A., claims to have received broadcasted concert from the General Electric Co.'s studio at Schenectady, 1000 miles away on a crystal. His "set" cost him about £3, and was built by himself. With it he has put up a world's record for concert reception on a crystal, which, in the ordinary way, has a range limit of 20 miles when the transmitting station is fairly powerful.

**TICK, TICK, IN BETWEEN SONGS.**

MOST people are familiar with the tick, tick, of the little time-beating instrument called the metro-nome, used by musicians. One American broadcasting station now starts up a metronome just when the last bar or so of a song or piece of music is being broadcasted. The tick, tick, of the instrument enables those listening-in to know they are still tuned in during the small intervals of silence that usually occur between the finishing of one number and the beginning of the next.

## The Audion Valve

By Claude McClure

North Sydney Radio Club

IT is safe to say that no instrument has done more to advance radio communication than the three-electrode valve.

Before dealing with this valve, however, I will give a brief outline of the electron theory and the principles of the Fleming, or two-electrode valve.

It is now generally accepted that the atoms of matter are minute systems of electrons which are united charges of electricity of negative polarity revolving about a central positive nucleus.

The electron is regarded as being the smallest charge of electricity known. If one or more electrons become detached from an atom of matter, the latter becomes what is known as a positive ion and will produce the phenomena associated with a positively charged body.

If one or more electrons are added to an atom it is then said to be a negative ion.

An electron is always attracted by a positively charged body and is repelled by a negatively charged body, or by another electron.

It was discovered by Edison, that if the filament of an electric bulb is heated to a red or white heat it emits electrons very rapidly in all directions.

If a metal plate is placed inside the bulb, adjacent to the filament, and connected to the positive of the filament battery, it will be found that the electrons will be attracted to the plate and a current will flow from the plate to the filament. If the plate is connected to the negative side of the battery, the electrons will be repelled and no current will flow.

Such a device is therefore a rectifier, permitting current to flow in one direction only.

About the year 1904, an English scientist, Dr. Fleming, applied this action to the detection and rectification of radio frequency currents, in receiving wireless signals, and invented the well-known valve bearing his name.

Following on the discovery of the Fleming valve, Dr. Lee de Forest, an American radio scientist, discovered that a network of wire, which he called a "grid," interposed between the filament and the plate, greatly increased the sensitiveness of the valve,

by controlling the flow of current in the plate circuit.

Dr. Forest's invention was termed the "Audion Valve" and he not only invented the grid but applied a high potential battery to the plate, at the same time. This high potential battery is known to-day as the "B" battery, which is connected in series with the receivers, or telephones, so that the positive pole of the battery is connected to the plate.

As already explained, a plate to filament circuit is secured by the electrons thrown off the filament being attracted to the positively charged plate, forming a path by which the current from the "B" battery may flow from the plate to the filament.

The function of the grid is to control this flow of current.

When the incoming, alternating, current signals place a negative charge on the grid, the plate current is decreased, and when the following half cycle renders the grid positive, the plate current is increased. By this action a very feeble alternating current on the grid may control a comparatively large volume of energy in the plate circuit.

By connecting the grid and filament of the valve across the secondary of a loose coupler it may be used as a detector of the most sensitive type.

In order to make the valve function properly as a rectifier, a small condenser in parallel with a high resistance, is connected in the grid circuit.

Since an increasing negative charge on the grid tends to reduce the plate current, then, while a wave train is rectified, the plate current is reduced, but the high resistance across the grid condenser slowly discharges it and the grid and plate revert to their normal value.

These variations, which take place with each wave-train, cause the diaphragm of the telephone to vibrate at the same rate as the spark frequency, when receiving spark signals, and at the frequency of the beats in C.W. reception.

The De Forest Audio valve has entirely superseded the Fleming valve as a detector and the latter is now only used for rectifying a.c. current for C.W. current and for battery charging.

You Pay Less and are assured of Certain Satisfaction when you secure

YOUR

# Radio Equipment

FROM

## ANTHONY HORDERNS'

NOTE THOSE PRICES :

Murdock's Double Head Sets,  
2000 ohm, 35s. set

Crystal Type Receiving Sets  
from 50s. set

Valve Type Concert Receiving Sets  
£16 10s.

Myers' Valves, 35s. each

Expanse V24 Valves, 37s. each

Expanse QX Valves, 37s. each

6 V 40 Amp. Accumulator, 52s.

6 V 40 Amp. Accumulator, 72s. 6d.



All Types of Terminals  
Screws, etc.

Condensers and Parts  
Honeycomb Coils, Crystals,  
Resistances, Knobs and  
Dials, Studs, Detectors

And other parts necessary for the  
Radio Enthusiast

**Anthony Hordern & Sons**  
LIMITED  
BRICKFIELD HILL, SYDNEY

Box 2712 G.P.O.

Telephone City 9440

## The Poor Man's Valve Receiver

ONCE a science has reached a stage where it can be of immense service to everybody, it is essential that its practical application should be on the simplest possible lines.

Radio-telephony has now come to be part and parcel of the daily routine of those more favoured in countries outside Australasia, and it is merely a matter of weeks, when we, too, may avail ourselves of the benefits of this wonderful new science, which seems likely to revolutionise the whole state of society, as we know it to-day.

Soon a radio concert receiver will be in every home, and in every shop, office and factory.

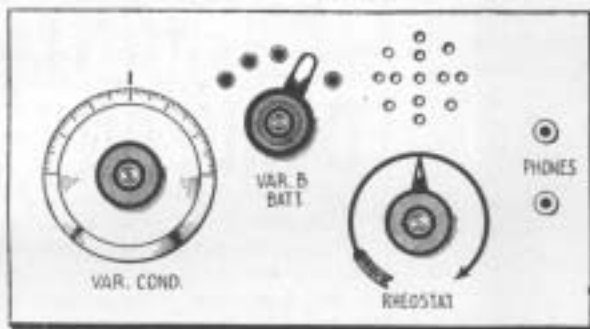

Fig. 1. Front of Panel, Single Control Receiver.

Everyone cannot be a radio expert, nor is it desirable that they should be. To render the new science a public utility, the receiving apparatus must be reduced to the simplest elements. It has been recognised, for some time past, that the ideal radio concert receiver should be one easily controlled, actuated by a single control unit, if possible.

Such a receiver has "arrived."

A radio valve receiver with one honeycomb coil, one variable condenser, one fixed condenser and grid leak, one valve, a 22½ volt "B" battery, a small "A" battery and a pair of phones, is surely the irreducible minimum in connection with receiver construction. Truly the poor man's valve receiver!

Best of all, one control, the variable condenser, for tuning!

Use the new 1½ volt valve, and the dry cell, "B" battery, and phones can all be packed away inside the cabinet,—portability in excelsis.

Fig. 1 shows the front of the panel, with a switch arm and studs for tapping the "B" battery at different voltages. The valve is mounted inside with a grating to view the filament. Just the filament rheostat control and the variable condenser knob to move. The top of the cabinet is hinged to permit any adjustments to be made at any time. A single honeycomb coil attachment, such as is used in mounting the coils, is screwed down to the base of the cabinet, and a honeycomb coil is plugged in to cover the concert wave lengths. If desired, a full range of coils to cover all wave lengths may be added, but, at most, two coils will cover all the wave

lengths, including those of amateurs, which we are likely to have in Australasia. For most concert wave lengths, one coil will do.

Although this receiver has been reduced to the simplest form of construction and operation, it loses nothing in efficiency.

Radio concerts and voice have been received on it at distances ranging from 500 to 1400 miles. There is no howl, buzz, or noise of any kind.

The circuit is somewhat critical, however, as regards the adjustment of the filament and "B" battery, but once those are set, the condenser knob does all the rest.

A 50 turn honeycomb coil covers a band of wave lengths ranging from 240 to 730 metres. This coil will cover the 440 amateur transmitter and the 600 metre spark range.

Fig. 2 gives the wiring of the receiver and it will be noted that a lead is taken from the aerial to the plate and then on to the phones. The grid lead is taken from the other terminal of the honeycomb coil with the fixed grid condenser and grid leak interposed as usual. A .001 variable condenser blocks the "A" and "B" battery currents, and the earth connection is at the junction of the two batteries. The writer tried the circuit with the positive of the "B" battery connected to the phones, as in the ordinary circuit, with the negative of the "B" battery coupled to the negative of the "A" battery, and the result was all that could be desired. In the diagram, a fixed condenser is dotted in, and this may be inserted or left out at will.

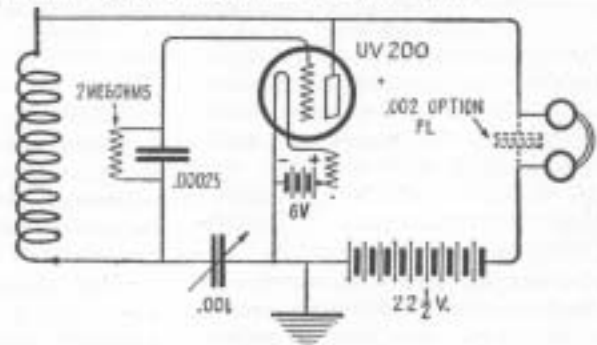

Fig. 2. Wiring Diagram of the Poor Man's Valve Receiver

The wiring is a very unconventional one and experimenters may be inclined to look askance on it, but it is a circuit worthy of being fully tested. Our readers can depend upon it to produce results, and we will be pleased to hear reports from amateurs who may elect to try it out.

Radio apparatus manufacturers, making up sets, cannot do better than make up a sample set on the lines laid down, as it may be sold at a price within the reach of a large number of people, and at the same time it reduces tuning to such a simple matter that anyone can learn to manipulate the receiver in a few minutes.

## Wonderful Crystals

JUST a crystal made of Rochelle salts, flat on one side and a dumpy pyramid on the other, wrapped in tinfoil, clamped between two aluminum plates and squeezed by little springs, and hooked into an electrical circuit, and you hear music from a distance with a pair of telephone receivers. Sound cannot be transmitted over a telephone wire without electric current, but there is no battery in the circuit in which the cry-

of the Western Electric Company, who has been termed a "crystal farmer" because he grows crystals from seed crystals. Mr. McLean is busy experimenting with different kinds of crystals, and has found that good effects may be obtained from various kinds of sugars, especially from the common rock sugar, the sugar candy of our youthful days.

The "piezo-electric" property of "pressure electricity" of certain cry-

we are leaning over the very eaves of the material universe, and looking into its other abysses. That is to say, looking into the Everlasting Nothing—from the standpoint of mere humans.

There are two types of scientific minds; there may be more, but for the purposes of this article two types will suffice.

One type of experimenter will at once visualise the vast possibilities of delving into "crystal farming" and testing. He will start in right away to pursue the subject, probing into science for science's sake. The other type of experimenter will want to know what use you can put, the crystal to, and if it will make a better crystal detector for radio.

During the war the crystals were used as submarine detectors.

They were placed in watertight tins, dropped over the side of a vessel and connected with a telephone circuit; their ultra-sensitiveness revealed the vibration from the propeller of a submarine when it was several miles away.

Beyond that, the crystals have not been harnessed to any real work, but the time may come when they will replace the carbon microphones in the telephone transmitter and receiver. They have no advantage in radio telephony, because whilst they are sensitive enough to detect the high frequencies of radio, they do not rectify them, and, therefore, they cannot take the place of the rectifying crystals.

The present problem, in connection with piezo-electric crystals is to find better kinds of crystals, and learn more about the organic crystals generally, which is where "crystal farming" comes in, a field of investigation in which amateurs might help and find an interesting hobby. This requires some chemical knowledge, but it is not difficult and should appeal to those who take an interest in pure science and like to extend their knowledge by experiment.

None of the inorganic crystals so far investigated have any great degree of sensitiveness, the quartz and gem crystals that Nature grew millions of years ago. Only the organic

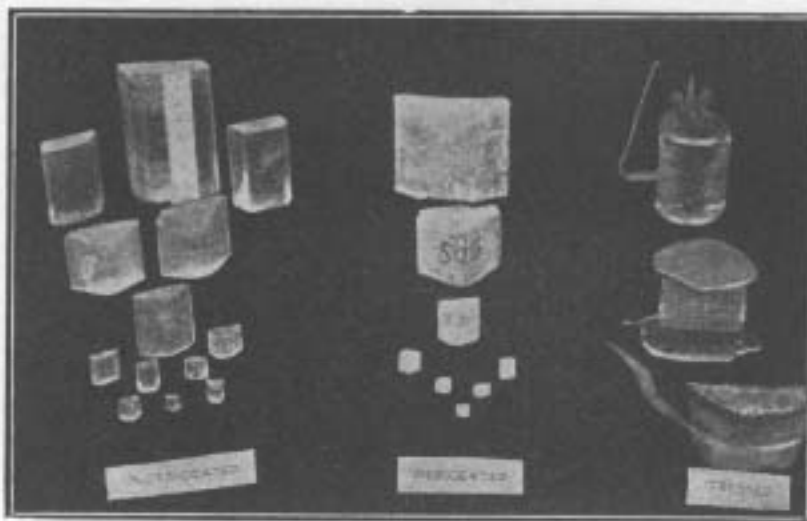

Stages in the Creation of the Piezo Crystals.

stal is employed. The crystal itself furnishes the intermittent currents.

It is hard to conceive the possibility of a crystal of Rochelle salts being a generator of electrical current; but twist it between the fingers, and it will register up to 500 volts pressure on a voltmeter.

Connect the crystal to a two or three-stage audio-frequency amplifier, and lay it on a piece of paper, and merely lifting the paper by one corner produces a noise like that of a gang of building demolishers at work. The ticking of a watch laid on the paper produces a row like a powerful pile-driver in action. Place a grain of sugar on the paper to attract a fly, and when he comes along, the suction pads on his feet cause him to sound like a cow squelching through a bog.

The discoverer of these wonderful properties of crystals is Mr. A. McLean, of the New York Laboratory

stals were discovered by the Curies. "Piezo" is from the Greek "piezein," which means "to press."

Torsion applied to the crystals converts mechanical energy into electrical energy, following certain lines in its crystalline arrangement or pattern.

Why certain inorganic crystals like quartz and gems should have taken different patterns in cooling from molten liquids or gases in the remote ages when the globe was young, or why organic substances like sugar and certain salts should cool from liquid into different patterns, is one of the unsolved riddles of matter.

But a most fascinating riddle! For if matter as we perceive it through our senses is nothing more than electrical energy, working in the impalpable ether (and no scientist has ever detected the ether by the most delicate apparatus), then in this electrical phenomenon, found in crystals,

crystals grown in the laboratory become satisfactory generators or transmitters of electricity under torsion. The best of them all thus far found is the crystal of Rochelle salt, a product of the juice of the grape. For practical purposes it has shortcomings, it is easily damaged by humidity, for one thing. Relatively few of the many salts, tartrates and so forth have been investigated. As an illustration of the field to be explored, it may be pointed out that of the various sugars available the only sugar yet tested for the piezo-electrical effect is the common rock sugar of the candy store.

Crystals are grown in several ways. Like plants, each particular substance thrives best under certain conditions. The purpose of growing crystals is to get them in masses large enough to generate or transmit sufficient electricity. The growing process is really freezing. Incidentally, ice is a crystal, and snow, probably with the piezo-electrical effect, but they have obvious shortcomings.

The Rochelle salt crystals are obtained by heating a solution of the salt in water and cooling it to supersaturation rapidly, in about twelve hours. A small "seed" crystal is added as the liquid cools, and the salt grows around it, taking its characteristic crystal formation. Masses weighing two pounds have been grown, but they are usually defective. After growing, the "raw" crystal must be "desiccated" or baked. This dries and cures it, shrinking the size and increasing its electrical properties. It also improves with time, if it is not affected by atmospheric conditions. Mr. Nicolson has crystals which, after several years' use, are just as effective as ever, and in some ways more effective than newly grown

crystals. Its production of electricity takes nothing from the crystal. Put under compression and torsion, it gives out electricity, and when released it takes up electricity. A handy comparison is with a sponge, from which water can be squeezed, and which will take up water when the pressure is relaxed, yet nothing is taken from the sponge in the process.



The Wonder Crystals Under Pressure.

After the crystals have grown and are baked, they must be dressed—coated with a special varnish and fitted with tin-foil electrodes. The small seed crystals used in growing the larger ones are obtained from previous croppings or by disturbing the solution in which crystallisation is taking place, thus causing it to break up in many small crystals.

Kelvin reasoned that matter is nothing more than electric swirls or "vortex rings" in the ether, comparable to smoke rings. If they swirl

without friction they will go on forever. But if there is the slightest modicum of friction, eventually the material universe must run down and disappear. That will happen so many aeons in the future that we needn't worry about it, but it is inevitable just the same.

The Hindus hold that the visible material universe is simply the "breathing out" of Brahma into the invisible spiritual universe.

"I will realise and express myself through material manifestations," says Brahma, and his out-breathing is the energy that makes spirit appear as matter—or the ether as Kelvin's vortex rings in terms of modern science. But there is an in-breathing, too, and when Brahma breathes in again, the material universe disappears and an unthinkable vast cycle of creation ends, and the universe rests in spirit until another out-breathing.

Kelvin didn't find Brahma, nor carry the microcosm of his vortex ring to the microcosm of Brahma's cycle. But his physical and mathematical results suggest that the Hindus may not be, after all, so far off in their metaphysical conception of the universe.

In the piezo-electrical phenomena of crystals, as in radio communication, we are perhaps dealing with the basic stuff of the universe—certainly the finest states of matter. And we are using some of them to enormously extend the range of human intelligence, so pitifully blanketed under its dense robes of flesh.

Yesterday radio communication was a beautiful laboratory plaything, useless to the practical man. What it has since become, the piezo-electrical effect of crystals may become to-morrow.

**D**ESCRIBING the transatlantic wireless tests made by six members of the Manchester Wireless Society recently, Mr. Y. W. P. Evans, secretary of the society, told a "Daily Mail" reporter that this was the first attempt by amateurs in this country to communicate with American amateurs by wireless.

The attempt was made from the society's station at Baguley, Cheshire,

### Transatlantic Tests

The following message was sent to two amateur wireless stations in America, one kilowatt of power being used:

"Here test message from Manchester Wireless Society to American amateurs. Please cable results."

The message was sent at 1 a.m.

Sunday and repeated each hour until 6 p.m. No replies were received.

The members heard, however, as many as 23 other American amateur stations communicating among themselves, one of them in California. This station used only 500 watts and its distance from Manchester is estimated at about 6,000 miles. In the opinion of Mr. Evans this creates a record.

# Using the A.C. Mains for Receiving and Transmitting Valves

By NEVILLE D. MOORE, Marrickville.

It is probable that many amateurs may have devised methods of utilising the direct current mains of the house lighting system as a means of obtaining the necessary high tension supply for the plates of receiving valves.

In very many places the supply is alternating current, and by adopting proper methods the a.c. current may be pressed into service for the plate current supply, thus doing away with all further trouble with high tension batteries, which rapidly

side of a large capacity condenser, "C" in Figure 1, the other side of which is connected by a common lead to the negative side of the filaments of the two valves, and the extremities of the secondary winding connected to the plates "A.1" and "A.2," of the valves 1 and 2 respectively, the induced a.c. of the secondary winding will be rectified, and fed into the condenser, charging it up positively as indicated in Figure 1. That is to say, that the same side of the condenser will always be positively charged, as,

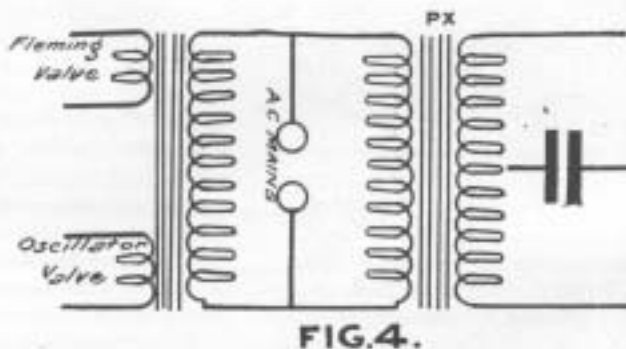
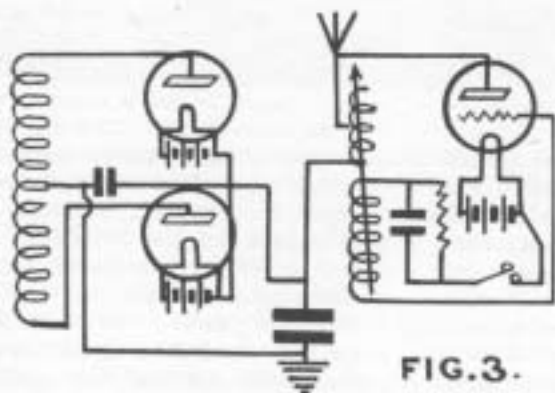
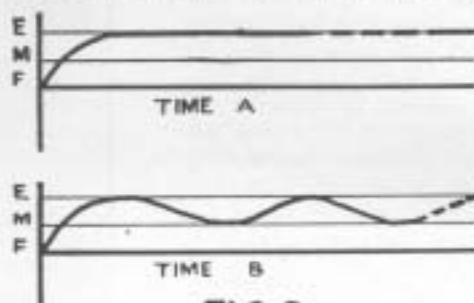
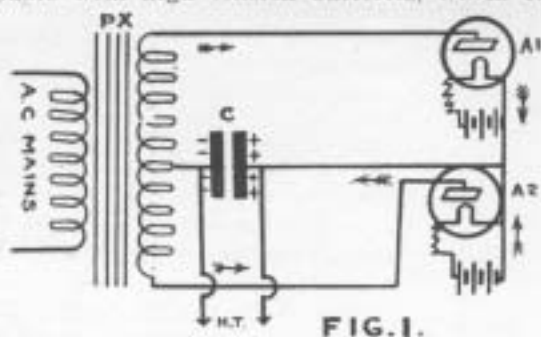

Fig. 1 The Power Transformer and Connections. Fig. 2 The Current Curves. Fig. 3 The Wiring Diagram of the Transformer Arrangement and Single Valve Transmitter. Fig. 4 A Step-down Transformer included to supply the Filament Current

deteriorate and become discharged, even when not in use. "X's," too, due to a faulty cell or cells, may be banished.

The apparatus needed is simply two valves of the Fleming type with filament batteries or transformers, a large capacity condenser, and a power transformer.

In Figure 1, "PX" is the power transformer, to the primary of which the a.c. mains are connected. Whether the power transformer is of the step-up or step-down variety will be determined by the supply voltage, and the voltage required for the high tension current for the valve plates.

If a tapping is taken from the middle of the secondary winding of the power transformer to one

when the one end of the secondary winding is positive to the other end, only the first valve will permit the current to flow in the circuit formed by the secondary winding, the condenser and the valve.

When the reversal of the a.c. current takes place, valve 2 permits current to flow through the circuit formed by this valve, the transformer and condenser, again charging up the side of the condenser positively. This will be easily followed by referring to the arrows in Figure 1, which indicate the direction of flow of the current. It should be borne in mind that only one valve can function at a time.

If the condenser is of suitable capacity it will flatten out the peaks of the rectified current by

acting as a reservoir, and if leads are taken from each side of it, a uni-directional high tension supply is obtained, suitable for the plate supply of the valve.

By this arrangement both positive and negative half-cycles of the a.c. current are utilised.

A modification of the method outlined may be employed for the production of interrupted continuous waves for transmission purposes.

There are several methods in use for the production of interrupted continuous waves, amongst which are—1, using a tikker, a mechanical device for making and breaking the circuit at any predetermined rate, so producing "tonic trains"; 2, the use of an independent commutator mounted on an extension of the armature shaft of a small motor, which, when rotated, makes and breaks the circuit similarly; 3, the application of an alternating e.m.f. to the plate of the transmitting valve. This latter method functions by only allowing the valve current to flow during the time when the positive half-cycle is on the plate.

Referring again to Figure 1, if the capacity of the condenser "C" is large enough it will flatten out the peaks of the rectified secondary a.c. as stated, and the resultant e.m.f. may be represented by a curve as in A, Figure 2. If this capacity can be reduced, the peaks will not be completely flattened out, and the resultant e.m.f., in that case, may be represented by a curve as in B, Figure 2. That is, there will be a distinct "ripple" in the high tension supply.

For the purposes of the receiver, the rectified current must be of a varying amplitude to produce sounds in the telephones, and continuous waves although rectified actually, do not produce this variation in amplitude, and, therefore, no note, as in the case of a "carrier wave" of telephony transmission.

If the high tension supply as detailed in the foregoing, is connected to the plate of a C.W. transmitter, in lieu of the usual generator or battery, it follows that the resultant waves emitted, although not actually "chopped up," will be of a varying amplitude, and therefore of a character suitable for reception with a crystal or other detector in a similar manner to the reception of spark signals and tonic trains. They may also be detected by a valve without the use of a heterodyne.

By making condenser "C" Figure 1, of a variable nature, or with two banks of condensers which may be connected in series or parallel, thus altering the value, the one set of apparatus will serve equally well for the transmitter, or the receiver, and we may thus obtain an inexhaustible supply of high tension current for either purpose. Figure 3, gives the wiring diagram for including the transformer arrangement with a single valve transmitter.

In Figures 1 and 3, separate filament batteries are shown, to simplify the diagram. In practice, the filaments may be coupled to one battery, or the a.c. mains may be further requisitioned to supply the filament current through a small step-down transformer as in Figure 4. This will have the still greater advantage of eliminating the filament batteries, which are often found to be discharged when specially wanted.

(In the last number of the Review, a diagram is given of a receiving set where a toy transformer is used to supply the filament current. A potentiometer is shunted across the transformer to eliminate the a.c. hum. When a power transformer with a tap in the centre is not readily obtainable, practically the same result may be obtained by shunting a potentiometer across the ends of the secondary winding of the power transformer.—Ed.)

## The Advantages of the Variable Grid Condenser

AS a general rule variable units in all radio circuits aid in obtaining better results because they afford a ready means for bringing the circuits into the most suitable balance; that is, for a given frequency or wave length best results may be obtained by employing a certain amount of inductance and capacity. Changing the inductance or the capacity may result in bringing the circuit in tune with a given wave length but its power of selection as well as its energy-absorbing values are found to exist in the greatest degree when a suitable balance of inductance and capacity is found. A variable grid condenser helps to make this balance possible in the grid-circuit and it offers a convenient method for making up the differences found

to exist in vacuum tubes. In the same circuit one vacuum tube may require a very small grid capacity for its best operation while another tube may require comparatively more capacity. With a variable grid condenser the most suitable capacity may be had instantly. The same thing applies to a given circuit and a given tube receiving from several stations. A variable grid condenser aids materially in building up desired signals and eliminating undesired signals. A variable grid condenser should be of comparatively low capacity; that is, it should have a maximum of approximately .0006 mfd.

It is rather difficult to determine without actual experiment whether or not a grid leak is required in a given circuit or, with a given tube. Vacuum

tubes vary greatly and the function of the grid leak is to keep a constant potential on the grid of the vacuum tube in order that the electronic flow may be thoroughly controlled. Some vacuum tubes operate most satisfactorily without a grid leak. It is also significant that a tube of this character employed in one circuit would give results without the grid leak, while in another circuit, the grid leak would have to be used in order to obtain the best results. The resistance value of a grid leak is also a matter of experiment. As a general rule a grid leak resistance of 2 megohms will suffice. It is generally a safe practice to employ a grid condenser and grid leak unit of the character now on the market having a capacity of .0005 mfd. and a resistance of 2 megohms.

## The Crystal Detector Receiver

WHEN we use a receiver embodying a crystal detector, which is capable of absorbing a relatively large amount of electrical energy, it is necessary to arrange some way of controlling and restricting the voltage applied to the detector if sharp tuning is to be secured.

As the proportion of the voltage applied to the detector (in comparison with the total voltage developed in the tuning system) is reduced, less energy is drawn from the persistently oscillating circuits, and the anti-resonating resistance effect of the detector assembly is made smaller. To secure maximum selectivity by radio-frequency tuning, we must provide condenser and coil circuits which can oscillate freely and in which resistance is minimized.

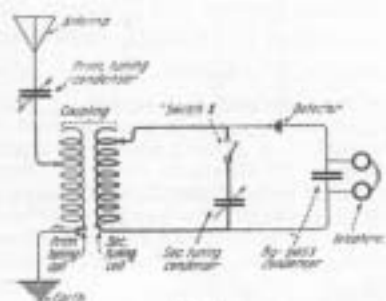

FIG. 1

The Double-Circuit Tuner with Crystal Detector

In a single tuned or resonating circuit, one which includes the aerial itself, the aerial and earth resistance, as well as the re-radiation resistance effect, remain in the circuit and put a limit to the improvement in tuning sharpness, which can be secured by reducing the detector voltage, but even under the best of conditions the single circuit tuner is hardly selective enough for working through severe interference.

If a second tuned circuit is added, as in a loose-coupler circuit, in which the resistance or damping effects are further reduced, the sharpness of tuning in the system will be materially increased.

The circuit of figure 1 shows the simplest way in which the tuned secondary circuit may be arranged with the crystal detector.

The usual aerial circuit contains

the primary tuning condenser (say, of .001 mfd. capacity), and the primary tuning coil, inductively coupled to the latter, is the secondary tuning coil, and across its terminals a variable secondary tuning condenser of either .001 or .0005 mfd. capacity. In the diagram a switch is shown to cut the secondary condenser out of the circuit, and this is for the purpose of facilitating tuning, as will be mentioned later.

Suitable choice of the sizes of the secondary coil and secondary condenser produces a closed resonating circuit in which the aerial and earth resistances appear only to the small degree reflected through the inductive transformer. Thus the sharpness of tuning in the secondary circuit and its resonant selectivity will be very high.

The only serious limitation to the selective power of the simple two-circuit receiver of figure 1 is the effect of detector resistance; as may be easily seen, the entire secondary voltage is applied to the crystal branch, and hence damping, due to the detector, will be a maximum.

The selectivity of the double-circuit tuner may be greatly increased by reducing the proportion of the secondary voltage applied to the detector. (The voltage mentioned being, of course, the voltage of the incoming signals.)

A simple way to do this is shown in figure 2, which differs from figure 1 only in the connection of the detector and telephone circuit across a part, instead of the whole of the secondary tuning coil. Hence the necessity for a tapped secondary in any kind of inductance used in this circuit, the secret of the efficiency of the loose-coupler.

In this manner the effect of detector resistance upon the secondary tuning may be cut down considerably, with a corresponding gain in resonant discrimination between arriving waves of slightly different frequencies.

A properly built receiver embodying the circuit of figure 2, accurately adjusted, will give a degree of selectivity surpassed only by the best

valve circuits. Moreover, the absence of batteries and the freedom from tone distortion, which are characteristic of crystal receivers, may be taken, together with the selectivity obtainable, in the manner just described, to recommend crystal receivers for concert or signal reception when the distance and power of the transmitting station render the employment of this kind of receiver feasible.

It will come as a shock to many radio experimenters to learn that the commercial operators on ships have received signals with crystal sets, without any amplification whatever, over distances in excess of 3000 miles. One operator, in making a trip from New York to San Francisco by way of the Straits of Magellan, received press

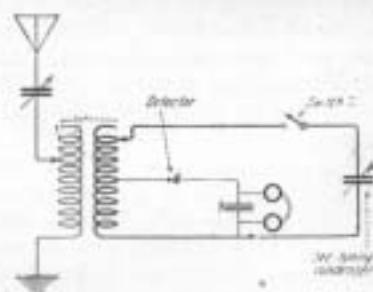

FIG. 2

In this form of the Tuner the damping produced by the Crystal Detector is reduced

despatches from the old Telefunken Station, located at Sayville, Long Island, nearly every night of the voyage. Another operator, on a trip from an East Coast port, through the Panama Canal, to Corral, Chile, which is 200 miles south of Valparaiso, received press, weather reports and time signals from the United States Station at Arlington, over the entire trip, with the exception of four days, and these four days were spent in the Torrid Zone, where static was extremely severe. No amplifiers were used, and the results obtained are not at all uncommon.

Regarding the crystal, it is doubtful if any crystal will give better results than may be had from galena. Merely procuring a piece of galena and putting it in the set will not do. It is necessary to purchase a large piece and break it up into smaller



pieces, testing each piece. It may be necessary to try many pieces before one is found that is truly sensitive, but it is worth the trouble.

A good method is to test out the crystals by having a double detector stand, or two detectors, which may be put into the same receiving circuit at will. One is used with any crystal, and the other is used as the test stand by placing the various pieces of galena crystal in it. As soon as one crystal is found which gives satisfactory results, it may be used as a standard and other crystals may be compared with it. In making the comparison, some single transmitting station should be picked out and the strength of its signals used as the determining factor.

Tuning should be proceeded with in the following order:—

1. Be certain that the crystal is in a sensitive condition, determining this by the buzzer test.

2. Disconnect the secondary condenser by opening switch "X" in the diagrams.

3. Adjust the primary tuning condenser, and the primary tuning coil

until the loudest signals are heard.

4. Weaken the primary-secondary coupling somewhat, close switch "X" and adjust the secondary tuning condenser until the desired signals are again heard at a maximum strength.

5. Move the primary condenser, setting slightly to increase signal intensity still further.

6. Having secured approximate adjustment as set out, find by experiment the best coupling value for signal-intensity and interference-freedom desired, remembering that for every change in coupling it may be necessary to re-tune slightly on both primary and secondary condensers in order to retain the greatest signal strength.

Once the rough settings for any given wave-length are learned, the tuning operations may be limited to those mentioned in paragraph 6.

It is a good plan to log the settings for the different wave-lengths until they are easily remembered.

Since the tuned condition of either primary or secondary circuit represents agreement between the fre-

quency of the arriving waves and the natural or free oscillation frequency of the circuit, longer wave-lengths will always be received with greater values of tuning inductance (more turns of wire in the circuit) and more capacitance (more of the moving plates of condenser between the fixed plates) than will shorter waves. Nevertheless, the same wave-length will produce resonant maxima of response at many values of inductance (more or less turns of wire in action), the corresponding condenser being reset to compensate for the change in the inductance. Thus, when a desired signal has been picked up, it is a good plan to try reducing the number of turns in the primary coil and increasing the primary tuning condenser accordingly. Some particular ratio of primary inductance to capacitance will ordinarily be found to give the strongest signals. The coupling and the secondary condenser should be slightly adjusted as each change is made in order to maintain complete resonance. In the same way it is advisable to try various ratios of secondary capacitance to secondary inductance.

## Major Newman's Panel Receiver

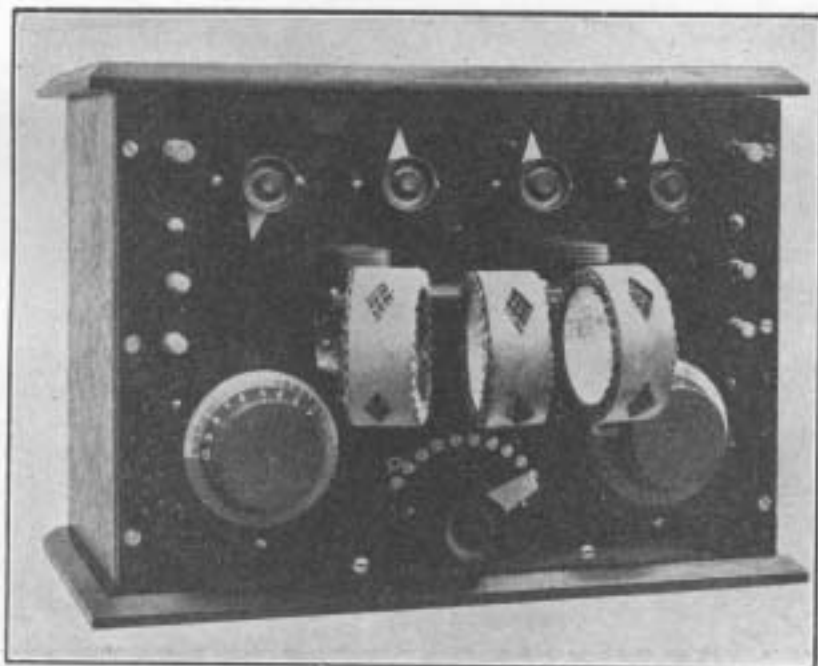

THE photo herewith is that of Major Newman's panel receiver, which is of very novel construction. Inside the front panel is a second one, on which the detector valve and two stages of the audio-frequency valves are carried. The top is hinged, so that it may be readily lifted to view the valves when switching on the current.

Two advantages are gained by enclosing the valves in this manner.

In the first place there is no danger of the valves being damaged, and it is a decided benefit to have the eyes relieved of the strain imposed upon them by the glowing filaments when operating the set. The dimensions of the receiver are given in an article in January number of the Review.

*Mr. Raymond Cottam Allsop**An Australian Radio Engineer*

R. RAYMOND COTTAM ALLSOP, the newly appointed radio engineer of the New Systems Telephones Proprietary Ltd., was educated at the Sydney Grammar School, and during his school days was a devotee of Father Shaw, who had established the Maritime Wireless Company at the well-known station at Randwick, Sydney, N.S.W.

This Company was known later as the Shaw Wireless Company and the call sign of the Station at that time was X.P.O.

Mr. Allsop started experimenting in wireless at the early age of ten years, and during his later school days received considerable help and guidance at the hands of Father Shaw, who was pleased to encourage his keen enthusiasm. On leaving school, he entered the Shaw workshops, in which the wireless installations for the Australian Coastal Stations were being manufactured under contract for the Government. A few years later the fascination of being a wireless operator on the sea called irresistibly, and after studying for his Australian and New Zealand Certificates, and obtaining them, he served as ship's wireless officer on a number of vessels, amongst them, the *Levuka*, the *Riverina*, the *Wyandra*, and the *Cooma*. In 1916 he joined the Troopship *Argyleshire* as senior operator. Early in the following year his vessel was torpedoed in the English Channel, and he was sent back to Australia to enter the laboratory of the Randwick Wireless Works, which had been taken over by the Naval Authorities.

In 1918 he was appointed senior wireless operator on the Troopship *Indarra*, and served on that vessel until two months after the armistice was signed.

During the time the Randwick Wireless Station was under the control of the Naval Authorities, military pack-sets, and special wireless apparatus for the Navy were manufactured there.

When Mr. Allsop was signed off the *Indarra*, he was again sent to the laboratory at the Randwick Naval Wireless Station, and continued there until it was taken over by the Repatriation Department.

Coming events cast their shadows before, and in the appointment of Mr. Allsop as radio engineer to the New Systems Telephones Proprietary Ltd., whose parent company in England is one of the largest radio apparatus and telephone apparatus manufacturing concerns in the British Isles, it is easy to discern that this Company is fully alive to the possibilities of the coming radio boom in Australasia, and that they are preparing to cope with the prospective demand for radio equipment, when broadcasting is started in real earnest.

In Mr. Allsop, the Company has secured a keen, capable and thoroughly practical radio engineer, an Australian who has had the decided advantage of being trained under such a master of radio science as Father Shaw. He will undoubtedly make his mark in the radio world, and we wish him every success.

*A Large Radio Apparatus Manufacturing Company has  
appointed an Australian as its Radio Engineer*



Mr. RAYMOND COTTAM ALLSOP

(of RANDWICK, SYDNEY, N.S.W.)

Who has been appointed Radio Engineer to the New System Telephones Proprietary Ltd.

## The Cavite Radio Station

IN 1902, Dr. Valdemar Poulsen and Prof. P. O. Pedersen, of Copenhagen, Denmark, invented the first undamped wave transmitter, using an arc system.

In the damped or spark system of radio telegraphy the aerial is given a series of electrical impulses of considerable intensity, but of very short duration, at comparatively infrequent intervals, and if we imagine a rather long cone-shaped figure, lying on its side, the wide or flat end of the cone would represent the ampli-

kilowatt spark set under the varying conditions imposed during the observations.

The signals of the arc were audible at San Francisco, and even at Pearl Harbour, under most favorable conditions, the distance between Arlington and Pearl Harbour being approximately 5000 miles.

The arc method was the first to be used in wireless telephony.

In the ordinary arc lamp as used for lighting streets, and in the projection of picture films, two carbon

includes the generator, the resistance or resistances, a condenser and an inductance.

The action of the capacity and inductance shunted across the arc has been described as follows:—

With a steadily burning arc, shunted by a capacity and an inductance, the capacity will instantly take upon itself a charge, and the current through the arc is simultaneously diminished or made smaller; the potential difference across the arc therefore increases, and this tends to further charge the condenser. This now reacts on the arc, still further augmenting its current, which in turn lowers its potential difference.

As the condenser discharges through the inductance, it not only fully discharges, but becomes charged in the opposite direction, just as a pendulum when pulled to one side and released, will not only go back to its original position, but far beyond it in the opposite direction.

When in this condition, it is ready to repeat the operation with more vigor than before, and so, persistent and undamped oscillations are set up by the condenser charging and discharging. The arc emits a musical note, and to obtain correct conditions for this purpose, it is positively essential that the inductance and capacity be properly adjusted to each other, otherwise the oscillations produced will be feeble and weak.

Mr. Valdemar Poulsen developed a special arc for radiophonic purposes, which employed one solid carbon electrode, and one metallic water-cooled electrode. With this arrangement Poulsen was able to produce powerful undamped high-frequency oscillations, with a periodicity of from 500,000 to 1,000,000 cycles per second, which were highly suitable for wireless telephony. This arc was burned in a chamber filled with hydrogen vapour, formed by admitting alcohol, drop by drop, and allowing it to become vaporized by the heat of the arc itself. In the perfected Poulsen radiophone arc apparatus, the carbon electrode is rotated by a motor and a very strong magnetic field is concentrated upon the arc proper.

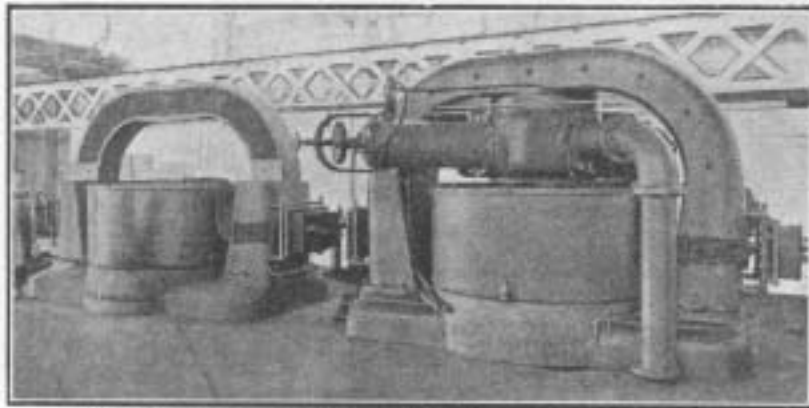

The Arc Converter of 500 Kilowatt<sup>10</sup> Capacity, at the Cavite Radio Station

tude of the wave at the commencement, and the point of the cone the final dying-down point. Half-way down the cone would represent the average amplitude of the impulse, so that the average power would be a very small fraction of the maximum.

In 1912 the United States Navy commenced the work of installing a chain of wireless stations, and about that time the Poulsen arc system was just emerging from the elementary stage, and the maximum power available was 30 kilowatts. For the purposes of comparison with existing spark stations, a 30 kilowatt arc set was installed at Arlington. With this set an aerial current of 50 amperes was obtained, whereas over 100 amperes was obtained with the spark set. Notwithstanding this difference in aerial current in favor of the spark set, the average received strength of the signal of the arc set at Key West, Colon, and other distant stations exceeded that of the 100

rods are held in suitable metal holders which are fitted with gears to enable the operator to close the carbon rods together or to separate them some little distance. The negative carbon is solid and the positive carbon has a core in the centre. The current is switched on and the points of the carbon rods are brought together for an instant, when an arc of light of dazzling brilliancy forms between the carbon rods when they are slightly separated.

For street lighting purposes the carbons are kept at the right distances apart by mechanical means, and this mechanism is controlled by electro-magnets. In the cinematograph projector, the carbons are fed together from time to time by the operator. In each case, the arc circuit consists of the mains from the generator and a resistance, the purpose of the latter being to keep the arc steady.

In an arc transmitter, the circuit

From time to time the arc converter has been improved to admit of higher powers being used. One of 100 kilowatts capacity was installed at Darien, midway between Colon and Panama City. Then San Diego station was fitted with one of 200 kilowatts. The Pearl Harbour station installed a 350 kilowatt set, then came Cavite with 500 kilowatts, and, during the war, the United States Government erected the Lafayette station, near Bordeaux, France, with an arc installation of 1000 kilowatts.

The accompanying photograph will convey some idea as to what one of these huge arc converters is like. The converter in the foreground is the 500 kilowatt arc installed at Cavite, and experimenters who listen in for the Cavite signals, will have some conception of what the apparatus is like that transmits signals over distances up to 6000 miles. The arc set in the background is the one which was installed at Pearl Harbour, Hawaii.

In this number of the "Review" there is an article describing the set of an American amateur who bridged 6000 miles with only 20 watts current supply. In a few weeks an attempt will be made, in the Trans-Pacific Tests, to bridge 8000 miles with one kilowatt of current supply.

In comparison it seems ridiculous for such gigantic apparatus to be used for a radius of 6000 miles, as is employed in the Cavite Station, but it has to be remembered that the big stations are put up for serious commercial or governmental work, and, as is obvious, such stations must be absolutely reliable, under all conditions, a desideratum which can only be achieved by powerful transmitting apparatus.

#### IDDY UMPY.

A FINE way of teaching the youngsters Morse! Buy them the game called "Iddy Umpty." It is just like Snap, only the letters of the alphabet and its Morse equivalent are used; and, instead of shouting "Snap," you have to say the letter in Morse and its name. It is really the greatest fun. These can be bought from any stationer's.

#### THE NEW 1½ VOLT VALVE.

The 1½ volt valve, working on a single dry cell, is coming into fairly general use in the United States. The single dry cell is the six-inch cell commonly used for ringing doorbells, and for the ignition systems of certain internal combustion engines. Such a cell is said to give quite a long service when used for the new valve.

Those who have put off obtaining valve receivers on account of the cost

in using these valves care must be taken to ensure that no more than 1½ volts is supplied for the filament, as they burn out very easily. The valve functions best when the filament is burned a dull red, and the satisfactory rheostat to use in conjunction with it is one of the carbon or graphite compression type.

For portable receiving sets, the new valve should prove ideal, as both the dry cell for the filament and the "B" battery may be included in the one cabinet.

#### THE ASSOCIATION FOR THE DEVELOPMENT OF WIRELESS IN AUSTRALIA.

AS was intimated in our last issue, this Association has been formed with the idea of utilising every possible means of developing wireless in Australia. It is a body largely composed of radio apparatus traders and manufacturers, and it is anticipated that the outcome of the advent of the Association will be the formation of a broadcasting company, something on the lines on which the broadcasting company has been formed in Britain.

A similar Association has partly been formed in Brisbane, and Mr. George A. Taylor, who represented New South Wales, at the Institute of Engineers' Conference in Adelaide, will endeavour to form other Associations in Western Australia, South Australia, and Victoria. These Associations will be federated into one big body, truly representative of all the radio apparatus traders, manufacturers, and others interested in wireless in Australia.

There is such a large number of questions involved in connection with radio broadcasting and in wireless matters generally, that the Association is not rushing things, but is rather more concerned in exploring every avenue, which bears upon the subject, in order that the greatest service, rendered in the best possible way, may be brought to the Australian people, in taking up this comparatively new science of radio telephony.

At an early date a further announcement will be made as to the progress of the Association's objective of getting all the States federated into one big Association.

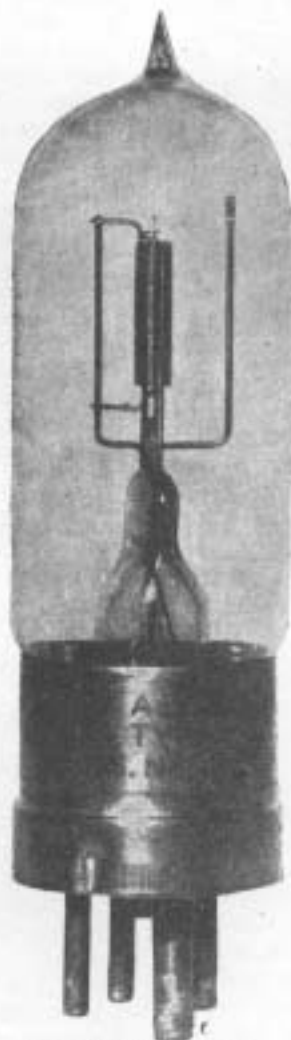

The 1½ Volt Receiving Valve

of the storage battery and providing means of charging it, can now avail themselves of valve reception at a nominal cost.

In cases where the ordinary type of valve is in use, an adapter, which plugs into the ordinary four-leg socket, is used for the purpose of placing the 1½ volt valve in the circuit.

# How to Begin: By an Amateur for Amateurs

## Article 4

IN my previous articles, I have traversed my experiences in deciding to start with a crystal detector receiver, adopting the honeycomb coil kind of inductance, and the construction and erection of an inverted "L" type of twin wire aerial.

My next step was to learn how to "tune in." This was a fairly simple matter with the honeycomb coils as, as will be seen by a series of tables given in the February number of the Review, it is easy to select a coil which will give the wave length required to be brought in. By the tables, a 50 turns coil would cover a band of wave lengths from 240 to 730 metres, and as I desired to test on the commercial wave length—which is 600 metres—I chose the 50 turns coil for the primary circuit. On learning that a 75 turn coil was a useful size, I procured one, and as this coil covers a band of wave lengths ranging from 330 to 1030 metres, I decided to use that one in the secondary circuit. I now became acquainted with the terms,—“coupling,” “loose-coupling,” and “tight-coupling.” “Coupling,” I found, meant the placing of two coils near to each other, and that they were “loose-coupled” when they were some distance apart, and “tight-coupled” when they were very close together, or, in the case of the kind of inductance termed the “loose-coupler,” when they were right inside each other.

From hints gathered from here, there, and everywhere, mostly as the result of asking questions of experimenter friends, I began to have some inkling as to what “inductance” meant. It seems that if the kind of electric current known as “alternating current,” is passed through a coil of wire, a similar kind of current, is set up, or “induced” in another coil of wire, when the second coil is adjacent to the first one. This is somewhat of a mystery to a beginner, but one soon recognises that it is a fact and has to be dealt with as such. It is something similar to that mysterious “something” which occurs when a penknife is brought near to a small portable compass. As most of us know, if the penknife blade is brought near to one end of the compass needle, the needle will be either attracted or repelled, and that it can be set swirling round and round, by moving the penknife round and round.

This particular “something” operates even though the small glass cover of the compass is between the compass needle and the knife blade. Bearing this in mind, it is easy to conceive that an electric current in one coil may pass through the air to another coil.

In coupling two coils, this passage of current through the air, or inductance, is greatest when the coils are tight-coupled, and least when they are loose coupled. The greater the inductance, the longer the wave lengths, and the less the inductance,

the shorter the wave lengths. Therefore, in coils having a certain range of wave lengths, the lowest range will be tuned in when the coils are at the maximum of loose-coupling and the longest waves will be brought in when the coils are tightly coupled.

A honeycomb coil holder permits two coils being moved away from each other to a maximum of 90 degrees, one of the coils being fixed, the other movable. Donning the head telephones, with the 50 turns coil in the primary circuit, and the 75 turns one in the secondary circuit, as mentioned, I listened in for 600 metre signals, and by moving the left-hand coil, the primary, slowly backwards and forwards, I soon found a place where the signals came in strongest.

I think that an experimenter will never forget the thrill he experiences, when, for the first time, he really hears wireless signals in the air.

I practised tuning in for some days on 600 metre commercial signals before I attempted to tune in radio concerts.

At last the great day arrived when I was to have the opportunity of hearing real music via wireless. A fairly powerful station about five miles away, was to experiment with broadcasting music on

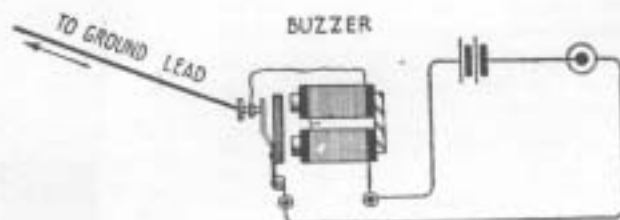

To Connect the Buzzer into the Receiving Set.

a 1200 metre wave length. For this I used the 100 turns coil in the primary circuit, and the one with 150 turns in the secondary. Varying my coupling, slowly and carefully, I presently heard clear sweet music in my headphones, not very loud, it is true, but quite loud enough to give me an infinitely bigger thrill than when I received my first wireless signal.

For the beginner, the secret of learning tuning is to have some tangible idea of where to place the variable elements to bring in the 600 metre waves for a start. With honeycomb coil tuning this is relatively simple, as the size of coil determines the wave lengths covered, and moving one coil from maximum to minimum coupling soon determines where the signals come in strongest.

If a loose-coupler, a tapped inductance, or a vario-coupler is adopted as the tuning inductance, the radio goods dealer will usually give the purchaser some idea as to where to place the variable elements, to tune in the 600 metre wave, and perhaps one or two other wave lengths likely to be required.

If a note is made of these points, it is only a matter of a little careful experiment to bring in any wave length desired which is within the range covered by the inductance.

It is somewhat difficult to give advice as to the best kind of inductance, because so much depends on circumstances. For crystal receivers, probably the loose-coupler is the most favored, and it can be very successfully used later on in a valve circuit if desired. Its disadvantages are its unwieldy size and the fact that it has certain effects termed "dead-end" effects. If the experimenter is handy with tools, and cost a consideration, he could not do better than make the spider-web tuner described in the February number of the Review, as very fine tuning may be had, without condensers, and at a very small cost.

Vario-couplers may now be obtained partly what is known as "bank-wound," a method of winding which considerably minimises the capacity effect. These couplers have a range up to 3000 metres.

The honeycomb coil inductance is the only one which will cover the whole range of wave lengths, and if the crystal detector receiver is only a means to an end, as it will be in the majority of cases, there will be no additional expense, when making up a valve receiver, save obtaining such extra coils as may be required to provide the third, or tickler coil, and the coils necessary to cover all the wave lengths the experimenter may desire to tune in.

As to the crystal itself, I would suggest experimenting with two, for a start, galena and iron pyrites.

In this copy of the Review an article headed "The Crystal Detector Receiver," goes very fully into the matter of using galena in the crystal detector.

One thing essential is a buzzer for testing the crystals to find out the most sensitive spot. On every crystal there is one particular spot which is much more sensitive than the others.

The buzzer is a small affair something like an electric bell minus the bell and hammer. A flashlight battery and a small switch are needed for the buzzer circuit. One terminal of the buzzer is joined to one terminal of the battery, the other terminal of the battery to the switch, and the other side of the switch to the remaining terminal of the buzzer. An ordinary push switch will do. To join the buzzer circuit into the detector circuit, all that it is necessary to do is to join the trembler, or adjusting screw, side of the buzzer to the earth or ground lead of the receiver. Press the switch to bring the buzzer into operation, and listen in, moving the contact point about on the crystal until the loudest buzzer sounds are heard; your receiver will then be in the most favourable condition to bring in the loudest signals.

The illustration herewith shows the buzzer connections.

Learning that the addition of variable condensers would give me finer tuning, and help me tune out undesired signals, I decided that I would add two to my receiver circuit. These could be

procured for panel mounting or for table use, and as I had no immediate intention of constructing a panel set, I preferred the table instrument type. These are made to stand up and were the most suitable for my requirements. Those in most general use were of .001 micro-farad capacity, so I obtained two of that size.

One was for the primary circuit and one for the secondary.

In the primary circuit, it is advantageous to be able to have the condenser in series or in parallel, according to what is required. If the condenser is in series, the lead-in of the aerial wire is attached to one terminal of the condenser, and the other terminal is joined to one terminal of the inductance.

The other terminal of the inductance primary is connected to the earth or ground lead. An alternative plan to connect the condenser in series, is to attach the aerial wire to one terminal of the inductance, the other terminal of the inductance to one terminal of the condenser, the other terminal being connected to the earth wire.

If the condenser is placed in parallel with the aerial circuit, the aerial wire is joined to one terminal of the inductance, and a wire connects one terminal of the condenser to the same inductance terminal. A similar wire connects the other terminal of the condenser to the other terminal of the inductance and from that point the earth wire is connected. The condenser is then said to be "in shunt" or "in parallel."

If the condenser is in series, either in the aerial lead or the earth lead, the effect is to tune the aerial circuit down to the shortest waves available with the coil, or setting of a variable inductance, whilst placing the condenser in shunt or parallel enables the longest waves to be tuned in. Series diminishes the wave length, shunt or parallel increases it.

The secondary condenser is always shunted across the secondary coil, that is one terminal of the condenser is joined to one terminal of the coil or secondary inductance, whilst the second terminal of the condenser is coupled to the other terminal of the coil, or secondary inductance.

Reference again to the article in this issue of the "Review," entitled "The Crystal Detector Receiver," will show a switch on one lead of the secondary, and this is for the purpose of making the tuning easier, which is a little hint well worth remembering.

Before passing on to the "valve" stage, it is well for the experimenter to thoroughly master all the possibilities of his crystal set.

In these days of the more aristocratic valve, the crystal receiver is apt to be looked upon as something very out-of-date and old-fashioned. It should be remembered that until quite recently, the crystal was the only receiver used on shipboard, and signals have been received by ship's operators over many thousands of miles. Some of the American amateurs claim to have received concerts on crystal detectors, without amplification, from high-powered stations, at distances up to 500 miles, and it is quite possible.

## Inspiration for the Trans-Pacific Tests

IT was the night of the trans-Atlantic tests, December 11th, 1921, to be exact, when (as all the world now knows) the members of the American Radio Relay League were trying to push their 200 metre signals over to England.

I was back in the heart of the bush in the northland of Canada on this particular evening. I had difficulty in keeping the shack warm, owing to a snuffling 30-below wind which found every unplugged crevice in the rough building. The day had been a hard one—most days usually are back here—and for an hour I had been listening to the "free for all" gang of amateurs. Some of their transmitters wheezed asthmatically, some trumpeted sonorously, and other C.W. signals came like the moaning of lost souls. After them came those amateurs who had qualified for special schedule tests by successfully transmitting over 1,000 miles overland in the preliminary tests.

It thrilled me to realise that I was listening to the cream of the American amateurs, endeavouring with their pet equipment to fling the paltry energy of a few dry cells across the ocean wastes to throbbing England. Paul F. Godley was over there—somewhere—listening. As I slowly moved the variometers I would hear 3DH of Princeton studiously sending his cipher and call letters, followed by IARY, who would valiantly swing in, reminding me of soldiers snatching the swords from the hands of fallen comrades.

It was close to 1 a.m., and I still sat listening to the boys pleading across the dark Atlantic for a hear-

### A Story told by an Operator up in the Wilds of Western Canada

ing—broken only by outside sounds of wolves howling faintly and the creak of moosehide thongs as my dogs outdoors grew anxious for battle. I had been looking forward to these tests for months, and had the receiver tuned to a hair. Indeed I had twice mushed fourteen miles to the Post Office through a blizzard and bad drifts for a spare bulb which never arrived.

And now the time so much anticipated was here. Would we fail to get across to-night? We fell down last night. I will never forget the miserable pang, when after a three hours' vigil checking up the strength of various stations' signals and speculating as to who would or should get across, I heard the monotone chant from MUU:

"No signals heard."

Was the task of getting through on 200 meters to Europe impossible? Some of the cleverest men in the radio world said it was.

Thus the minutes slipped on, my mind first going over the fizzle we made of the last attempt during the early part of the year, wavering with doubt over last night's "No signals heard" from Godley, only to be eventually buoyed up by new hope which fed on dying hope.

During the tests I had removed the aerial and ground from the set,

and still some of the boys pounded through to me—here in an Arctic world—on the edge of everything!

It was 1.59 a.m. I snapped in the honeycomb coils on the longwave set, threw the aerial switch over to the 300 foot single wire, and began sliding the condensers over for Paul's message from MUU at 2 a.m. On my way up I passed the Old Reliables, NDD the Saddler, NPM the hand-bell ringer, and WSO the blacksmith. I was busy juggling out WII and WGG (scratching a clean, quiet spot for MUU) when—I heard the sweetest music that ever passed across a vacuum tube. It came like a vesper to a tired soul at eventide, over the seas from Carnarvon, Wales—over a hundred blazing cities and leagues of darkened unmapped forests—right into this little shack here, nestling in the curving snowbanks of a white wilderness, telling me that Godley had "heard amateur signals from America in Scotland!"

Did I hear aright? Had I fallen asleep and just dreamed this thing? With drooped jaw I heard WII repeat Godley's message to our head-quarters at Hartford, Conn.

A surge of emotion swept over me as I removed the receivers and dropped my head on my arms.

It had been done.

An American amateur, crouched on Scotland's bleak coast in the chattering misery of an icy, slanting rain, had accomplished a feat which has placed puckers of new thought on the broad brows of those eminent scientists who had smiled behind their hands. The American amateurs had achieved the impossible!

### BY THE WAY

teries for your "B" or Plate Battery, sandwich a piece of old inner tube between each section, and, above all, keep the cells away from damp.

Don't fix a galena crystal in heated metal, as the heat impairs the sensitivity of the crystal. The crystal should be held in its cup by three set-screws.

If you have a garden long enough, one line of 14-gauge copper wire is

more efficient than a number of shorter wires, and is easier to erect.

Sometimes the tuning switch may grate or squeak on the contact studs. Cure this by keeping the studs clean and free from dirt.

Keep the spaces between contact studs free from dust or metallic particles. Use a small dry camel hair brush when dusting.

Aerials may not be slung across streets.

Refrain from taking your receiver to pieces in order to satisfy your curiosity as to how it works. If you are a novice the results will probably be fatal, and you will be none the wiser in the end.

Don't jump up suddenly when you hear wireless concerts. Remember, you will have the telephones on, and a sudden jerk will probably upset the whole of your apparatus.

If you use pocket-lamp dry bat-



**SERIES-PARALLEL SWITCHES.**

TO the veteran experimenter, it is a simple thing to connect up a series-parallel switch, but to the beginner, the matter is not so easy, and a little help in that direction may not come amiss.

A switch of this kind can be done without, of course, but it is a troublesome process to be constantly unhooking the condenser connection to



Figure 1.—A Double-Pole, Double-Throw, Series-Parallel Switch.

place it in either series or parallel with the aerial tuning inductance, as may be required, to tune in the signals desired.

A small, double-pole, double-throw switch may be bought for a few shillings, and the convenience gained is well worth the small expenditure. One of those switches about three inches long, with porcelain bases, is quite good enough for the job.

Figure 1 shows the wiring up of a switch of the double-pole, double-throw kind. With the switch closed

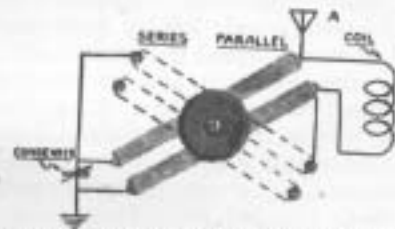

Figure 2.—A Panel Type Series-Parallel Switch.

to the left, the condenser is placed in series—when closed to the right, it is in parallel with the aerial tuning inductance.

Figure 2 shows another kind of switch, the switch usually employed in panel mounting. As shown in the illustration, the condenser is in parallel with the aerial tuning inductance, and turned to the position shown by the dotted lines, one bar becomes inoperative, whilst the other places aerial, aerial tuning inductance, and aerial condenser in series with each other.

**THE RADIO DESK.**

Another Radio Exhibition is in the air, and when it eventuates it will be visited by people of all classes, kinds and conditions.

There will be those who cannot afford elaborate outfits, but there will also be present many to whom money is no object.

For the edification of the latter, receiving and transmitting sets built into beautiful specimens of the cabinet-maker's art, should be on view, with the idea of proving that radio sets may be pieces of furniture fit to be placed in any lady's drawing-room, or in any gentleman's study.

The photo herewith depicts such a set, and its simple, artistic lines must appeal to all who believe that utility and artistry can always go hand in hand.



In the bottom of the desk, the "B" battery, "A" battery and Tuner or other charging device are contained.

By making the bottom a little deeper, or by placing the loud speaker horn on its side, with a flexible bend to connect to the microphone portion of it, the loud speaker may be enclosed.

In the back of the desk a frame loop aerial may be fitted, and if hinged, may be swung to any position desired, to obtain maximum signals.

CUBA is soon to have a large broadcasting station, local interests having decided to erect one after hearing some of the United States broadcasters and observing the enthusiasm displayed by American visitors to the island.

Already there are numbers of receiving sets in daily use in Cuba, picking up American broadcasters.

The  
House for  
Electrical  
Supplies

Our Stocks include :

INSULATORS

ENAMELLED  
WIRE

S.S.C. WIRE

D.S.C. WIRE

D. HAMILTON & CO.  
LIMITED

283 Clarence St., Sydney

## The Electron

ARRANGING the elements in an ascending scale, we have some seventy different forms of substance beginning with Hydrogen, with an atomic weight of 1, and ending with Uranium with an atomic weight of 239.

The Uranium atom contains about 200,000 electrons and is the heaviest and most complex atom known to science. So ponderous is it, indeed, that sooner or later it breaks down spontaneously, forming an atom of Radium (which is less heavy and less stable than Uranium) and one or more simple atoms of the light gas Helium. Uranium evidently marks the limit of electronic combination.

Uranium, Thorium, and Radium mark the end, not the beginning of a course of development. They signalize, we can dimly see, the point where evolutionary design, so far pursued with success, ceases to be practicable. As the outcome of its execution we have the whole series of the chemical elements variously constructed of a primal stuff. All that primal stuff consisted, we are driven to believe, in a crowd of "electrons," almost infinite in number, incoherent in arrangement, boundlessly diffusive in space. How were these electrons combined together to form an atom? It was not possible without the application of some force. It involved the doing of work.

Electrons are, no doubt, adapted for agglomeration, yet they will not agglomerate unless under compulsion. Just so much energy as a substance gives out in going to pieces was assuredly expended in putting it together. A gram of radium, according to Professor Rutherford's indisputable statement, contains a store of power sufficient to raise 500 tons a mile high. An engine of 1,000 horse power would be kept working for three hours to produce this small quantity of the heaviest of known metals. Whence did this power come? How and why was it directed in this particular channel? Here we are met by the impenetrable secret of creative agency.

Almost all we know concerning the electron has been learned through the study of the phenomena of radium and of the electric discharge in Crooke's Vacuum Tube. ("X-Ray" Tubes.)

We have seen how electrons unite to form the different kinds of matter. Let us now consider them as sources of force.

We shall find that the different manifestations of energy are the result of vibrations or perturbations of electrons acting individually or in collected units. The most subtle and most elusive type of force is that which we call radiant energy, and consists of transverse waves propagated in the ether by the orbital or axial rotation of individual electrons, either free or in the atom. Phenomena involving sudden or periodic interference in the motion of electrons through solids, liquids or gases, also give rise to waves of radiant energy. The crack of a whip causes a single pulse or radiating wave in the air which impinges on the ear drum as a

sudden sharp noise; the alternate to-and-fro vibration of a piano string, or the other hand, sends out a series of gradually diminishing waves which blend to form a musical note, of a pitch or frequency equal to that of the vibrating string. Single electrons moving at a high velocity, when suddenly stopped by some solid body, send out isolated "pulses" in the ether; when these pulses follow each other with great rapidity, X-Rays are generated. It is the extremely short wave length of these impulses which enables them to penetrate solids which are opaque to slower vibrations. X-Rays may be likened to a succession of "whip-cracks" in ether, while light waves are like musical sounds in that they result from the sustained vibration of electrons swinging in their definitely determined orbits. The bright lines of the spectrum are single pitches or "tones," their wave length and frequency being determined by the rate of rotation of the electrons in the different chemical atoms.

From what has been stated regarding the electron it will be readily understood that the advent of the "Electron Theory," while greatly broadening and amplifying our knowledge of the nature and causes of natural phenomena, nevertheless makes it necessary for a thorough revision of the laws and definitions which have been generally taught and accepted up to the present time. For example, we have been taught that electricity flows from the positive to the negative pole of a circuit, and that the electricity in a positively charged body exists in a condition of increased pressure or concentration, the reverse being true in the case of a negatively charged body. Physics has taught us that electricity is an indefinable, elastic "something," equally diffused throughout all matter; and that by removing a portion of the electricity contained in a given body, and adding it to another body, a positive charge would be communicated to the latter; while the first mass would be left in a negative condition. A positively charged body was analogous to a chamber filled with compressed air; a negatively charged body, to one filled with rarefied air. These statements have been generally regarded as correct, and have been of no little assistance to the student of electro-physics, but our recently acquired knowledge of the real nature of electricity has demonstrated the incorrectness of the above statements, as well as of many other explanations and theories promulgated in the various books on physics and electricity, which have been published in recent years. The profound, epoch-making character of the discovery and elaboration of the "Electron Theory," is not generally realised at the present time, except by investigators and students of pure science.

Many are almost entirely ignorant of the great practical significance, and the wide vista of possibilities which have been opened to us by the discovery of the "Electron Theory."

(To be Continued.)

## The Pries Reflex Receiver

THE greatest fascination about radio science is its glorious uncertainty. The 100 per cent. radio experimenter starts off with a crystal, and with it tries out every circuit he can dig up, plus a few of his own, and then passes on to the valve stage with a single valve receiver. This stage opens up a delightful field of circuit exploitation, and, presently, the "very best" hook-up is attained, the end of the one stage cul de sac reached.

The next adventure into the unknown is in the direction of audio-frequency amplification. To use

the least troublesome. The matter is finalised by the purchase of a good transformer, and experiments with a number of circuits begin.

When the receiver is equipped with three stages of radio, a detector, and three stages of audio-frequency amplification, and a loop aerial made up, well, surely, the apex of achievement has been reached.

Just as the radio fan begins to think that he has the best thing on earth in the way of receivers, he is awakened with a jolt to find an Armstrong producing marvellous results with half

metre wave band, as on the 500 to 5000 band, the reflex circuit presents no difficulty.

The general principles of the circuit are that the valves are made to perform a double duty, first, as radio-frequency amplifiers and next as audio-frequency amplifiers.

It is impossible to use more than two stages of audio-frequency amplification in a reflex amplifier, as the loud audio-frequency signals tend to paralyze the valve as far as radio-frequency amplification is concerned. Either a crystal or a valve may be

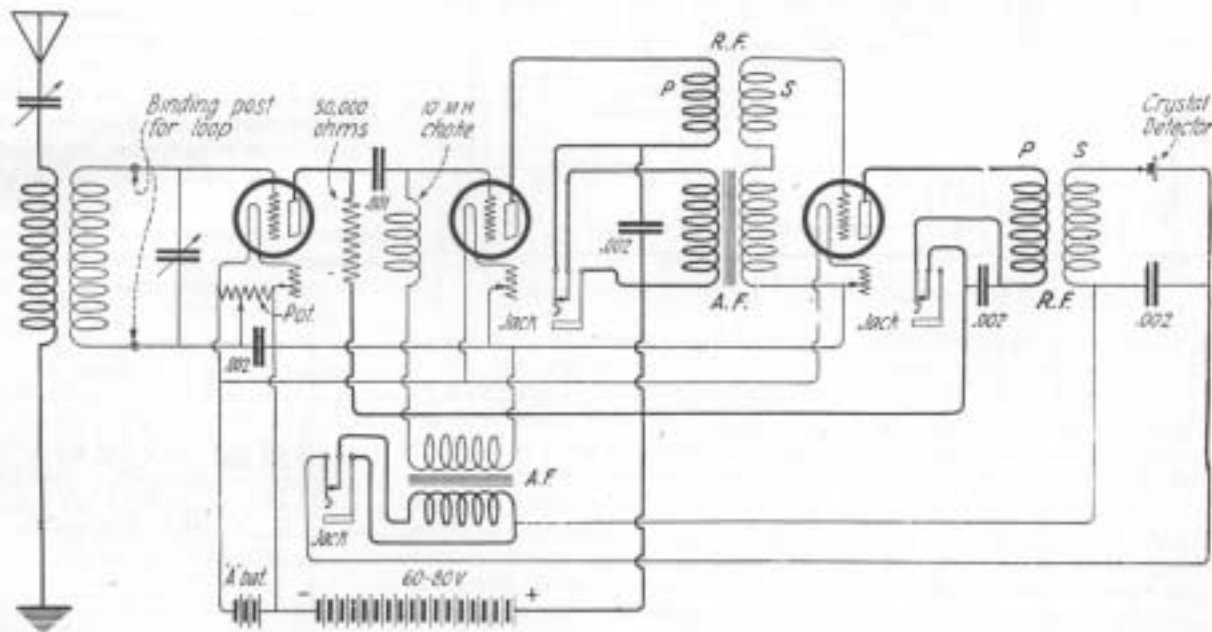

Fig. 1. The Three-valve Reflex Circuit.

Dana Gibson's words, the experimenter goes into the audio-frequency stage "like a timid fly approaching a piece of rock candy" and ends up by emulating the actions of "a hungry orphan in a bun-shop," for, after all, the make-up of an audio-frequency amplifier is simplicity itself. One stage is tried, perhaps two, and then it is inevitable that the third stage be tried to decide the all-important question of how much the third stage will increase the volume of sound.

The radio-frequency aspect is viewed very gingerly. It seems to present very many difficulties. A mass of literature is searched to learn which system of radio-frequency is

the number of valves, a Dr. Satterlee obtaining clearer and louder signals or music with a new device in tuning, and now there comes along another method of making three valves and a crystal do the work of six valves.

This latest improvement in radio science is the development of the Pries Reflex Receiver.

The principle is not entirely new, but the application of it to practical use has been delayed pending the manufacture of radio-frequency transformers, which would be efficient on short waves.

With Radio Corporation U.V. 1714 radio-frequency transformers, which work as efficiently on the 200 to 500

used as the detector. The circuit may include one, two, three, or four valves.

A well-known American radio apparatus manufacturing Company has just placed on the market a Pries reflex receiver that brings in broadcasted concert up to 1000 miles away with a loop or coil aerial.

The receiver includes a two-foot coil aerial and tuning condenser system. It has a range of 250 to 500 metres.

The coil aerial is tuned by a vernier condenser and there is no variocoupler or other inductance. Terminals are provided for the usual earth and outside aerial connections, so that an experimenter may try the

ordinary connections if he so desires.

If an outside aerial is used, it is always used in combination with the coil aerial. The received powers of both outside and coil aerial are then additive and both aerials are tuned by the same vernier condenser.

In the reflex circuit the received power stored in the tuning condenser is impressed upon the grid circuit of the first tube and is then amplified through each of the three tubes at radio frequency, building up the received signal from an infinitesimal

condition essential for them to be highly efficient amplifiers.

The Pries Receiver employs a crystal rather than a valve as a detector. This use of a crystal sensitized by a radio-frequency amplifier between it and the aerial has never been previously applied to commercial sets due to the presence of many difficult problems involving instability and reaction. Radio engineers have for a long time appreciated the inherent value of the solid rectifier in this general use, but it remained for Pries

taneously a double duty, first as amplifiers of radio-frequency currents and then as audio-frequency amplifiers without instability or squeals and with each amplification separately efficient. Added to this phenomena there is a certain amount of radio-frequency "reflex" which is accomplished by adding to the combined amplification some of the double-frequency radio-frequency generated in the detector circuit and led back via the mutual capacity of the transformer windings and the capacity of the wiring and circuits in the set. "Reflex" is not feed back or regeneration. In feed-back, changes in plate-circuit potential caused by corresponding grid-circuit potential variations are reimpressed in identical wave form, phase, and frequency upon the grid circuit, and they result in additional changes in plate potential, or in amplification. In the phenomena of "reflex" an output circuit which may be a grid-circuit or a plate-circuit or a circuit coupled to either or both of them is passed through some device which changes any one, two, or all three of the characteristics of the phase,

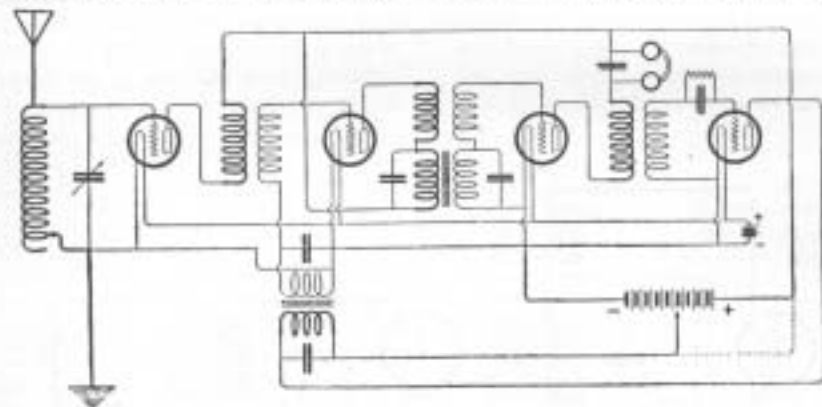

Fig. 2. The Reflex Circuit with a Valve Detector

value to a very great amplitude. The signal is then rectified by a galena crystal detector and "reflexed" back and its potential raised through an audio-frequency transformer to the grid circuit of the second tube. It is then further amplified at audio-frequency in the third tube and the complete output drawn off the plate circuit of this tube. A control is placed in the grid circuit of the first tube to enable a continuous variation of the grid circuit damping over a range resulting from the grid current losses that follow the change of grid potential from a value of zero to a positive value equal to the potential drop across the filament. This is not a grid "bias" for the purpose of securing rectification or operation on the non-symmetrical portion of the tube characteristic nor an application of grid potential for the purpose of securing operation on the symmetric portion of the tube characteristic as clearly evident from the range of these values and the fact that neither of these effects if present are in any manner useful in the circuit. All the remaining grid circuits of the amplifier are tied in permanently at zero potential and are therefore in a con-

dition to solve the problems in a balanced adjustment, free design and attain the inherent benefits accruing from its use. Some of these are: a total absence of parasitic noise at the rectifier which ordinarily occurs in a detector valve and is amplified at audio-frequency to a disagreeable amplitude, the relatively greater freedom from distortion of a crystal as compared with a detector valve, the elimination of a number of detector valve adjustments, and the necessity of changing them very materially as the valve ages, and the saving of a valve and the filament and plate powers required to operate it. In this use of a crystal, all points on the crystal give reception and this may be further secured by using a crystal detector of the "Everset" type. In the case of the Pries Receiver, all points on the crystal give reception, and adjustment of the contact point merely gives a variation of the received signal. Furthermore, the adjustment remains fixed for months since it is not affected by static or the factors which are present in the usual crystal circuit.

In the Pries Reflex Circuit, the valves are made to perform simul-

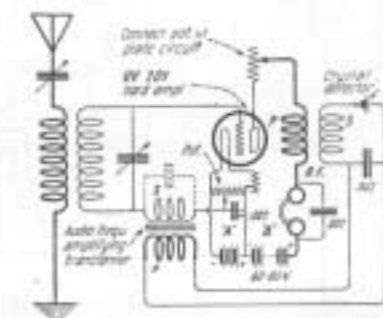

Fig. 3. The Single Valve Circuit with a Crystal Detector.

wave form or frequency of the output wave, the resultant—which is usually of a complex form and may even be discontinuous periodically—is then impressed upon a grid or a plate-circuit of the tube device which is primarily causing the "unreflexed" output. Reflex may be at higher frequency than the output frequency and usually a harmonic, or at a lower frequency, or both step up and step down may be simultaneously present.

Several reflexes are possible simultaneously in a valve. In feed-back, factors are present which hold the system in phase. In reflex no such factor is useful in most of the simple forms.

## How to Make Fixed Condensers

SOME old photograph negative glasses, a supply of home-made waxed paper, a pound of stout tinfoil, some varnish, a few switch point studs fitted with a couple of nuts each—given these, the radio experimenter may go ahead making fixed condensers to his heart's content.

The cedar wood of which the cigar box is usually made, is very porous and it will absorb a good quantity of shellac varnish.

Well varnished cedar wood is probably as good an insulator for fixed condenser purposes as it is possible to obtain.

Shellac varnish is very easily made. A small wide-mouthed jam jar is half filled with orange or white shellac obtained from the nearest store that handles paints and varnishes. The jar is then filled up with methylated spirits, procured from the chemist, and with an occasional shake up, the varnish will be ready for use within two hours. This mixture is the French Polish of commerce, and the amateur may use it either with a brush or with a rubber to renovate his radio cabinet. A French Polish rubber is made of a wad of cotton wool covered with a piece of well-washed old calico or linen. The rubber is held against the mouth of the jar or bottle, and, by tipping up the latter, the wad is allowed to soak up the varnish or polish. To prevent the rubber sticking, the face of it is smeared with the slightest trace of boiled linseed oil.

Polishing is done by a circular motion of the rubber, and occasionally, an up and down stroke is given to even out any traces of the circular track. When the work is nearly completed, the rubber is dipped in methylated spirits and the job "spirited off." This process gives a nice finish to any woodwork parts of a radio receiver or transmitter.

Whilst on the subject of shellac, it may be mentioned that fused shellac makes the finest cement possible, for the purpose of putting "feet" on the bottom disc of variable condensers, intended for experimental table use; for joining glass rods and metal parts in making up spark discharges for a Tesla coil, etc., and last, but not least, it will repair the family crockery.

Fused shellac is made by melting ordinary orange shellac with a jeweller's blow pipe (cost, 5d.) or over a gas flame, but the blow pipe method is best as it obviates the chance of burning the fused shellac and so spoiling it.

A tin lid say 2½ to 3 inches in diameter is used for the fusing receptacle, and is filled with the shellac. The flame is applied and as the shellac fuses, it is turned over and over with a hat pin until it is all fused. It is then turned out on the face of the family flat iron, just as toffee is turned out on a cooling slab, and before it sets, it is rolled into stick form, about four or five inches long and three-eighths of an inch in diameter. To apply the cement, the glass and metal, or two pieces of crockery, are heated and the cement placed in a candle or gas flame until it commences to run, when it is smeared on the parts to be stuck together. Unsightly holes, accidentally made in cabinet work, can be filled with shellac cement, the surface taking the polish or varnish, equally with the timber.

To return to making condensers, the first thing to remember is that the capacity of the condenser is calculated, in the main, upon the area of tinfoil that actually lies between the glass plates, waxed paper sheets, or mica sheets.

The writer has used waxed paper condensers which have stood up to a 5000 volts pressure without breaking down. Glass plates will easily stand up to a voltage of 60,000, and mica will stand enormous voltages.

By the time signals and music are heard in a wireless receiver, the voltage and amperage are negligible, only the frequency remaining as it left the transmitting station. For receiver purposes, therefore, the paper condenser is well above requirements.

The following table gives the sizes and the number of pieces of tinfoil for the various capacities—

Approximate capacity.	Area of Foils.	No. of Foils.	Dielectric Thickness.
.0005	1 x 1½ inch	2	.002
or	½ x 1½ "	3	"
.001.	2 x 1½ "	2	"
or	½ x 1½ "	5	"
.003	2 x 1½ "	5	"
or	½ x 1½ "	11	"

The figures of the table are for mica insulation or dielectric, but if two sheets of stout writing paper, immersed in paraffin wax are pressed together with a hot iron, the waxed paper will be just as good.

The area of the foils is the active area which will be between the waxed sheets, and each foil must be cut half an inch longer for the over-lap to allow for connections.

For a .0005 condenser, there will be required, two pieces of tinfoil, each one inch wide by 1½ inch plus ½ inch for the overlap, total 2½ inches as the length of the foils. Two pieces of the varnished cedar wood, should be cut, half an inch wider than the foils and half an inch longer. The total length of foils is 2½ inches, so the length of the pieces of cedar will be 2½ inches. The width of the pieces of cedar will be 1½ inch, to allow a space of quarter of an inch on the sides of each foil.

The pieces of cedar are clamped together and a one-eighth hole bored in the centre at each end, and about a quarter of an inch therefrom. These holes are to take the switch point studs which are to act as bolts for the purpose of bolting the condenser together. The bottom piece of cedar is laid down on a table and a piece of the waxed paper, the full size of the wood, is laid upon it. One of the 2½ inch foils is now laid on the waxed paper, one end of it flush with the left edge of the wood; another piece of waxed paper, 1½ inch wide by 2½ inches long is laid on top of the foil, and this is followed by another foil, this time one end of the foil is placed flush with the right hand edge of the wood. The foils should be placed in the centre, so that at the sides, they will be overlapped by the waxed paper by quarter of an inch. The foils and paper should now be stabbed at each end over the hole already bored in the pieces of wood, to allow the bolt to be passed through. As the bolt it passed through at each end a washer should be slipped on to it, underneath the foil, and, pressing in the bolt a little further, another washer is to be slipped in on top of the foil. The washers must be thin, and as they are intended to give better contact with the tinfoil, they should be sandpapered before being placed in position. If a short length of cleaned fine wire is soldered to one of the washers and then coiled round the bolt thread, it will give better contact still.

If several thicknesses of waxed paper and several foils are to be used, a somewhat different procedure would have to be followed. In this case the pieces of wood should be 2½ inches long by 1½ inch wide. The first piece of waxed paper should be the full size of the pieces of wood. All the other pieces should be cut 2½ inches by 1½ inch. As before, the first piece of foil (2½ inches long by 1 inch wide) is laid on the waxed paper, one end of the foil being brought flush to the left edge of the wood. A piece of the 2½ inch waxed paper is now placed on top of the foil, in the centre of the wood, that is with half an inch of space on the sides. This leaves the right hand edge of the first foil half an inch from the right hand edge of the waxed paper lying on top of it. A second piece of foil is then placed on the top of the second piece of waxed paper, this time with one end of the foil flush with the right hand edge of the wood. The

left hand end of the second piece of foil is now seen to be half an inch from the left hand edge of the second piece of waxed paper.

Foils and waxed paper sheets are laid on each other alternately left and right until the required foils and sheets are in position. On the left there will be a number of half inch lengths of foil projecting from the waxed sheets, and the same obtains on the right hand side.

The foils, only are stabbed this time, in line with the holes in the top and bottom pieces of wood. The bolts are slipped through the bottom holes and through the stabbed foils, the washers are put on as in the preceding case, the top piece is placed in position and the whole is firmly bolted together. It may be necessary to put two or three washers at the tops and bottoms of the foils, to make up the thickness of the foils and waxed sheets. Finally paraffin wax is melted and poured round all the edges to keep the moisture out, the superfluous wax being scraped off to give a neat finish.

A washer should be placed over the bolt before screwing on the binding nuts.

This type of condenser will serve admirably as a grid condenser, or for the purposes of a stopping or by-pass condenser in any position in the receiver circuit.

For transmitters, mica or glass plate dielectric is best.

A glass plate condenser of .01 mfd. capacity is made up of twelve glass plates which may be old photographic negative glasses 10 inches by 8 inches. The tinfoil is cut into pieces 8 inch by 6 inch, thus allowing a space of one inch on all sides. The glasses are coated on both sides and the area of tinfoil employed is therefore, 24 sides, each 6 inches by 8 inches— $48 \times 24 = 1152$  square inches of active conductor. If 10 inch x 8 inch negative glasses are not procurable, the ordinary "whole-plate" negative, which is  $8\frac{1}{2}$  inches x  $6\frac{1}{2}$  inches, may be used. In this case the foils would be  $6\frac{1}{2}$  inches by  $4\frac{1}{2}$  inches to allow the inch of space round the foils on all sides. This space, by the way, is allowed in all condensers to prevent the charge leaking from one conductor to the other.

In making up glass condensers it is an improvement to shellac varnish the glass plates for one inch on all sides, as the glass is apt to collect moisture and so provide the path for a short circuit.

To make up a .01 condenser with  $8\frac{1}{2}$  inch x  $6\frac{1}{2}$  inch glass plates, with a tinfoil conductor of  $6\frac{1}{2}$  inches x  $4\frac{1}{2}$  inches area, 20 plates would be required, each coated on both sides with the tinfoil.

About six pieces of tinfoil of the  $6\frac{1}{2}$  inch x  $4\frac{1}{2}$  inch size may be cut out of the average sheet of tinfoil, leaving a strip nearly two inches wide as waste. Instead of cutting the foils with the necessary connecting lugs on them, the writer cuts the foils square to the dimensions, and uses the waste strips as the connecting lugs. It is far easier to construct a glass plate condenser in this way, as cutting foils with lugs entails both unnecessary waste and trouble.

The foils are stuck to the glass plates with photographic mountant, a thick paste supplied by photographic dealers.

The tiniest trace of the mountant is rubbed all over one side of the foil, and any superfluous paste rubbed off with the finger. A roller squeegee, as used in photography, is employed; to roll the foil into optical contact with the glass, at which point the foil is practically held to the glass by atmospheric pressure. This can only obtain if every bubble is carefully rolled out and a perfectly plane surface secured. The two inch wide waste strips are now cut into six inch lengths. These are doubled in the middle to give a double-fold lug for strength purposes.

The lugs will be three inches long when doubled, as is obvious. At the open ends, mountant is applied to stick the lug ends together, the mountant not being allowed to

go more than  $1\frac{1}{2}$  inch from these open ends. The open end of the lug is pasted with mountant on the outside for another  $1\frac{1}{2}$  inch distance up, sufficient to cover the one inch space of bare glass and to overlap the foil, half an inch, thus securing contact. The roller squeegee is again employed to get the pasted ends of the lugs down flat.

The plates are paired. That is to say, that the first lug is pasted on the left of one foil, the left edge of the lug being in line with the left edge of the foil, and on the opposite of the first plate, another lug is pasted, and as the plate has been turned over to allow the lug to be pasted on, this will now be the new left of the plate, and the lug is pasted on the left edge of the second foil, so that looking at the plate in its now "turned over" position, the second lug is on the left and the first lug is on the right and attached to the other side of the plate. With the second plate laid on the table, a lug is pasted on to the right hand side. When this plate is turned over, the two lugs of the inner sides of both plates will come together. When the second plate has been turned over, the second lug of this plate will be pasted on the new right hand side of it. A third plate is then prepared with a lug on the left hand side, turning the plate over brings the lug to the right hand side, and another lug is pasted on the new left hand side. And so on. When the condenser is finished, all the insides of the plates will be connected by lugs that touch each other. All the outsides will be connected by lugs which are separated from each other by the sheet of glass. Keeping in view the first plate, which has now a number of other plates lying on top of it, it will be remembered that the first lug, the one at the bottom of the pile is on the right hand side. All the lugs on the right hand side, including the first one are connected together. The condenser finishes with a plate having a lug on the left hand side, as the condenser is viewed from the top of the pile. All the left hand side lugs are connected with this one. All the insides will now be connected together, as will all the outsides.

Those who may have made up glass plate condensers, with glass and foil placed alternately will probably be puzzled by this pairing method, but the efficiency and compactness of such a condenser amply repay the slight extra trouble.

As connectors, two four or six inch lengths of stranded wire should be soldered to two pieces of brass such as may be taken off disused flashlight batteries. The brass is well sandpapered and each piece is then rolled into its respective group of tinfoil lugs, starting the rolling at the top of the lugs and finishing the roll at the glass. The shellac cement mentioned herein is then used to stick the rolled lugs and the conductors down to the top of the glass plates, care being taken not to tear the lugs in the process.

For Tesla coil work, the condenser may be immersed in oil which renders it much less liable to puncture. Transformer oil is the oil used or boiled linseed oil will do.

Making waxed paper is a very easy process. A saucepan of boiling water with an enamelled iron pie-dish on the top of it serves to melt the paraffin wax. The paper should be fair quality writing paper in either the quarto or foolscap size, the latter being most convenient. One edge of the paper is immersed in the wax, and the whole sheet pushed through it.

If working over a gas-stove, the heat from the flame under the saucepan will help to drain off the superfluous wax very rapidly, and holding the sheet a second or so in a draught, the wax quickly sets, when the sheet may be laid on an old newspaper to set thoroughly.

From the figures given the tinfoil area required for any size of condenser may be readily calculated. The tinfoil conductors are made up in sizes to suit the convenience of the maker. It does not matter if the tinfoil is on one sheet or fifty.

## Amateur Radiophone Transmitters

MANY experimenters fight shy of transmitting on account of the cost of installing a rotary converter or transformer, and the various extras which go to make up the transmitting set.

There is no need to wait until the finances are sufficiently strong to bear the inroads of purchasing generators or transformers, as the valve receiver may be quickly converted into a transmitter in a very simple manner.

The three-coil honeycomb coil holder is slightly rearranged, the primary being the fixed coil, in the position occupied by the secondary coil in the ordinary receiving circuit. Across this centre primary coil is shunted the .001 or .0005 variable condenser. From the aerial side of the primary coil and shunted condenser, a lead is taken to the plate of the valve, which may be the ordinary receiving valve, but an amplifying valve would be better. The other side of the primary coil and the other terminal

For the high tension supply, two methods of obtaining this are available, according to whether the line supply is d.c. or a.c., and without using either a rotary converter or generator or a transformer.

If the supply is d.c., enquiry is made at the power house to ascertain if either of the leads is earthed. In most systems, one lead is earthed, but in others, there is no earthing of the supply leads.

If neither of the power house supply leads is earthed, the two wires of the house electric lighting system are simply coupled into the circuit, the negative wire being connected to the positive of the "A" battery and the positive wire earthed; or, the positive wire of the house lighting system may be coupled to the earth side of the centre, or primary coil, and shunted condenser, and the negative wire of the lighting system earthed. If the first plan is adopted, the aerial system is also earthed in the usual way. That is, that there is the customary lead to

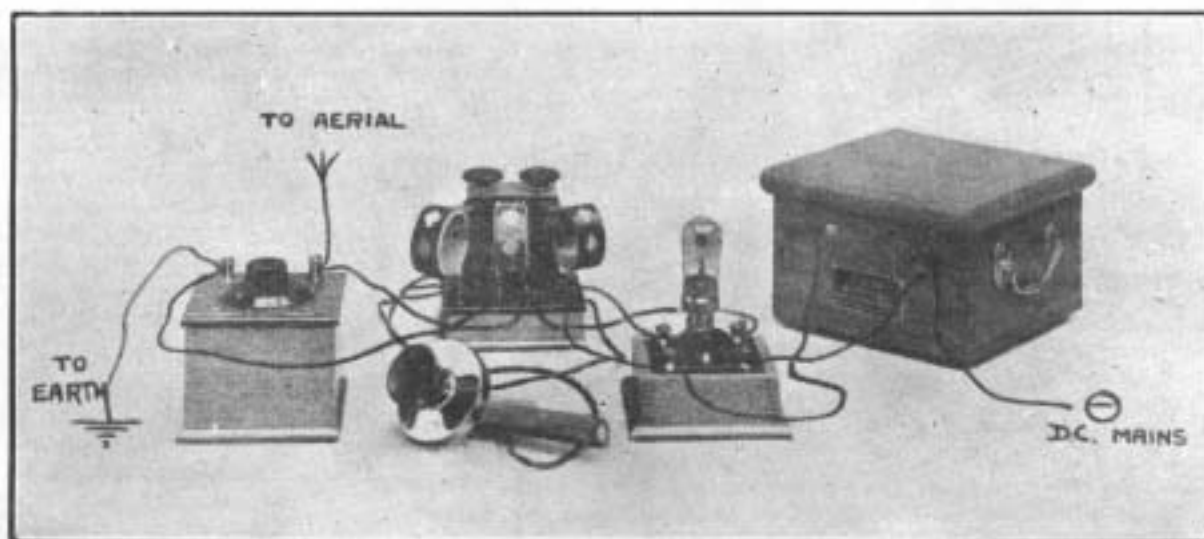

Fig. 1. General View of the Transmitter.

of the condenser are connected to the earth wire. The coil usually used as the "tickler" in the receiving set, has one side connected to the grid of the valve, no grid condenser or grid leak being employed. The other side of this "tickler" coil is connected to the negative side of the "A" battery.

The remaining coil, the one occupying the position in the holder usually assigned to the primary in the receiving set, has both leads connected to the leads from an ordinary telephone microphone, such as is used on the Post Office telephones.

For 440 metre transmission, the centre coil, or primary, is a honeycomb coil of 35 turns, the coil in the grid circuit is one of 75 turns, and the coil to which the microphone is attached is one of 35 or 25 turns.

The range of this transmitter is anything up to 20 miles and the modulation is all that could be desired.

earth from the centre or primary coil and terminal of the shunted condenser. If the second plan is followed, that of coupling the positive wire of the house lighting system to the earth side of the centre or primary coil and condenser, the negative wire of the house lighting system is earthed, and, in addition, the positive side of the "A" battery is earthed.

Both "earths" may, of course, be joined to the one common earth lead in either of the above cases. In so using a common "earth," it means, in the case of the first plan, that the positive wire of the house system is coupled to the earth lead from the aerial system, and from the junction a lead is connected to earth; in the case of the second plan, the negative wire of the lighting system is connected to the positive terminal of the "A" battery, and an earth lead taken from the junction of these two.

It is not always easy to find out which is the negative

lead and which the positive lead in the house lighting. If the proper coloured cables are used, red for positive and black for negative, there is no trouble. If, however, these leads cannot be readily seen, a simple way to determine the polarity is to cut a potato in half, and in one half press both wires of the lighting system, keeping them about an inch apart. The positive wire will stain the potato green, and around the negative will arise a white froth or scum. The wires should then be carefully marked, one with a piece of red rag, the other with a piece of black.

If the negative of the house lighting system is, on enquiry, found to be earthed, the positive wire of the house system is connected to the earth side of the primary

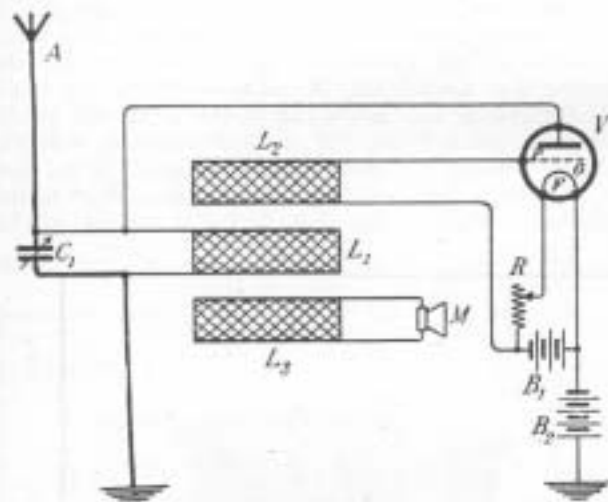

Fig. 2. Wiring Diagram with Positive Main Earthed.

or centre coil, and shunted condenser of the transmitter. The negative wire of the house lighting wires is not used at all, as the negative side of the system is already earthed at the power house. The only earth in this connection is that of the transmitter set, which is a lead from the positive of the "A" battery to earth.

When it is the positive of the d.c. system that is earthed at the power station, the negative of the house wires is connected to the positive of the "A" battery, and the positive of the house wires is not used. In this case the earth of the transmitter is the usual earth of the aerial circuit.

In practice, a wooden adaptor plug should be plugged into the most convenient light socket, and a length of flex brought to the transmitting set. Applying the potato test for the polarity, fix whichever wire is going to be used to a switch, so that the house lighting power may be switched on or off at will, and carefully cover the other wire with insulated tape and then bind it back on the flex with more insulated tape. Needless to say, no one would attempt to use a house current without taking the precaution to have a three-inch length of low power fuse wire in between the switch and the connection to the transmitting set. A fuse is a safety valve which often saves a lot of trouble and expense.

An experimenter should always have by him, a four-inch by three-inch piece of thin wood, say, cigar box wood, mounted on four small insulators and equipped with two pairs of terminals, 2½ inches apart, and three inches

between the two pairs. Underneath the board, connect one terminal of each pair with a three-inch length of fuse wire, and there is always a double-pole fuse ready for any experiments.

With this transmitter very fair results may be obtained with a couple of 45 volt blocks of "B" battery, but 200 or the 240 volts of the house lighting systems will give better results.

In cases where the house current is a.c., a method is shown in the April number of the "Review" for rectifying the a.c. and boosting it up to more than twice the voltage of the line supply current by an arrangement of condensers and electrolytic rectifiers, thus rendering a transformer unnecessary. As the voltage is low, paper condensers are all that are needed, and the waxed paper for these is very easily made. Mica dielectric is only necessary when the voltage runs into the thousands.

Four six-inch test tubes are used for the rectifier, giving full wave rectification. The electrodes are half-inch wide strips of aluminium for the positives and strips of thin iron or lead of the same width for the negatives.

Four old glass jam jars will do as well as the test tubes, and will be stronger.

Footscape size paper, similar to that used in the "Review" in thickness and texture, but of a much poorer quality, would be about the right thing for the paper condensers. A couple of pounds of paraffin wax would cost plenty of paper for the condensers, and the pound or so of tinfoil would not cost much. The whole unit could be constructed for few shillings, and the problem of high tension current supply solved for all purposes, receiving, amplifying or transmitting. The experimenter who wants to get the best out of an amplifier and a loud speaker should certainly construct the unit mentioned, as, with a power valve as the last valve of the amplifier, with 200 to 300 volts on the plate, the loudest results are obtained.

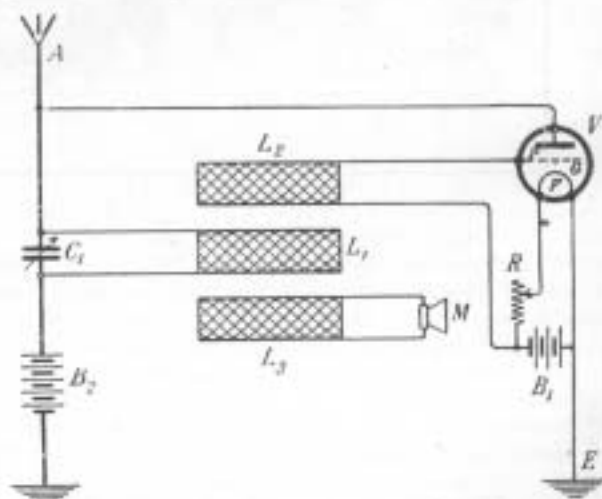

Fig. 3. The Diagram when the Negative Main is Earthed

As was pointed out in the April article referred to, it is a simple matter to control the voltage delivered by the rectifier-booster unit by means of a lamp in series, with the supply lines.

It is an improvement to connect a .002 fixed condenser between the earth side of the shunted condenser and the



positive side of the "A" battery, and this fixed condenser may be one of 1 mfd. capacity when using the power lines, to overcome the commutator ripple or hum.

Having settled the high tension problem according to his circumstances, with batteries, or d.c. or a.c. power line supply, the next question for the experimenter is the operation of the transmitter.

There are three controls. The aerial circuit condenser is first adjusted to give the wave length required. The grid circuit coil is next adjusted, and finally the microphone coil is varied to the right position relative to the primary or centre coil.

For a start, the microphone coil is kept well away from the primary, the grid circuit coil is brought near to the primary until the maximum radiation is obtained. If the microphone coil is brought close to the primary, it may be necessary to bring the grid circuit coil nearer to the primary to obtain the loudest speech. A tuned receiver placed adjacent to the aerial will give some indication of the results attained by the variation of the three controls.

To work the transmitter on a 300-metre wave length, three honeycomb coils of 25 turns each may be used, and

the condenser should be placed in series in the aerial lead of the circuit.

After reading the foregoing, it will be seen that a transmitter need not be costly, and as most radio fans are eagerly looking forward to the time when there will always be something to test with, the experimenter who has refrained from installing a transmitter on account of the cost, may now go ahead with his transmitting experiments, and, at the same time, give his fellow experimenters radio-phoned speech or music to test out on.

Figure 1 gives a general view of the transmitter, with the variable condenser on the left, the accumulator on the right. Assuming that the positive lead of the d.c. supply is earthed at the power house, the negative only, of the house supply is shown connected to the right hand side, or positive, terminal of the accumulator in the box.

Figure 2 shows the wiring of the transmitter with a "B" battery as the high tension supply, which battery is replaced by the house lighting negative wire when the positive lead is earthed at the power house.

Figure 3 shows the same circuit when the negative lead is earthed at the power house.

## Radio and Audio-Frequency

THE essential difference between radio and audio-frequency amplification is this: With radio-frequency, the very slight current produced in the receiving antenna system by passing waves from a transmitting system are caught and passed through amplifying devices designed to permit this current to oscillate—that is, to flow back and forth at the same frequency it passes through the ether. With audio-frequency the current from the detector tube is passed through successive amplifying stages, not at the natural frequency of the signal as it passes through the ether, but at a frequency very much lower, which is within the range of audibility. In the case of radio-frequency amplification, the incoming signals are amplified by means of a local source of energy before they reach the detector tube, while audio-frequency amplification takes place after detection.

Detection requires a certain amount of energy for its proper functioning, and it is obvious that several stages of audio-frequency amplification would be valueless where the strength of the incoming signal was insufficient to produce detection. It is here that radio-frequency is valuable, for it builds up the infinitely weak signal to a point where proper detection may take place, and from this point on it

is possible to increase the signal audibility by the audio-frequency amplification method.

Radio-frequency amplification alone will not operate a loud speaker over any material distance. In fact, the general rule may be laid down that loud speakers may only be employed where at least one or two stages of audio-frequency amplification are employed. Radio-frequency amplification has not been very popular in amateur circles until recently for the reason that different transformers were required for the various wave length ranges and the range of any one transformer usually covered but a few hundred metres. This difficulty has been materially reduced by the introduction of a new radio-frequency transformer designed to function satisfactorily over a particularly broad range of wave lengths. This broad range is made possible by taking advantage of the balancing effect found to exist when an iron core radio-frequency transformer is employed. A transformer of this character having a wave length range of 200-5,000 metres may now be had and another transformer having a range of 5,000-25,000 may also be procured.

A very significant fact regarding radio-frequency amplifiers is that the

FOR BETTER RESULTS

USE

DE FOREST

Radio Equipment

INTER-PANEL TUNER

The De Forest Interpanel Equipment consists of a series of Panels, each one constituting a complete piece of apparatus in itself, but so designed that it may be combined with the other Panels to form an attractive, efficient Radio station for both Radio Telephone and Telegraph reception. We wish to emphasize the fact that the Interpanel Line is convenient for experimental work and quick changes of hook up.

**INTER-PANEL AUDION CONTROL** contains Tube Receptacle, Grid Leak and Condenser, Rheostat, and Variable Battery Switch

**ONE-STEP AMPLIFIER** designed to add to Audion Control Panels

Write Today for our beautifully illustrated Catalogue of Wireless Supplies. We stock Wireless Parts of every description

**Burgin Electric Co.**

382 KENT STREET, SYDNEY

results obtained by a single stage of radio-frequency amplification and a vacuum tube detector non-regenerative circuit are approximately the same as those obtained by a vacuum tube detector alone, employed in a regenerative circuit of proper design.

## Tips for Fans

### A VARIO-COUPLER CIRCUIT.

NOW that bank-wound vario-couplers are obtainable with ranges from 200 to 3000 metres, it is a type of in-

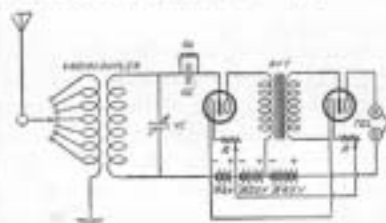

ductance that is bound to find a great deal of favour. This circuit is a non-regenerative vario-coupler circuit, to which one stage of audio-frequency amplification is added. Although non-regenerative, it brings in telephony quite clearly and in good volume.

It can be made regenerative by adding a variometer in the plate circuit. The variable condenser across the secondary may be either .0005 or .001 mfd., the latter would be preferable for wave lengths above 600 metres.

### AN ELECTROLYTIC DETECTOR CIRCUIT.

AN electrolytic detector consists of a fine platinum wire fused into a glass tube, with the tip inserted in dilute nitric acid. As nitric acid causes too much hiss which is always

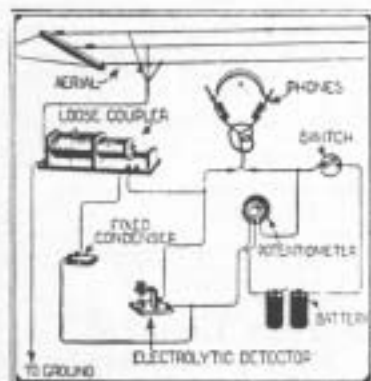

present with this type of detector, dilute sulphuric or hydrochloric acid may be substituted with beneficial results.

A potentiometer is necessary to regulate the necessary current which may be furnished by a flashlight battery.

### A CHEAPLY-MADE SINGLE-VALVE RECEIVER.

THIS is the circuit of a single valve receiver using spider web coils as the inductances.

One-sixteenth of an inch thick celluloid is admirable for winding spider web coils on; it looks well, is a good insulator, it is strong and is about the cheapest material obtainable. The primary is wound with 40 turns of 26, 27 or 28 single cotton-covered wire, and is tapped at every ten turns. The

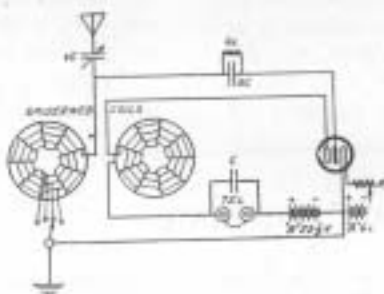

"tickler" coil is wound with 60 turns of the same wire, and it is mounted so that it may be swung away from the fixed primary coil.

Celluloid discs, 4½ inches in diameter will be suitable, and there are nine slots in each disc. If a tail is left on one of the sections of each disc, about two inches long, by three-quarters of an inch wide, it will serve for the mounting connection. The variable condenser is .001 mfd., the grid condenser is a fixed one of .0005 mfd. capacity, and the telephone condenser is also fixed and of .001 mfd. The grid leak is the usual 1 or 2 megohms.

### THE VARIO-COUPLER-VARIOMETER CIRCUIT.

CIRCUITS, and yet more circuits, is the prayer of the average experimenter. For fine tuning the circuit employing variometers is unsurpassed. This is not a theoretical circuit but is one which has proved highly efficient and is the single valve circuit

An American bootblack has installed a wireless receiver, together with a large sound magnifier, on his stand. Customers are entertained with concerts and news.

preferred by a very prominent radio experimenter. The inductance may be a loose-coupler, or two honey-comb coils, if a condenser of .001 mfd.

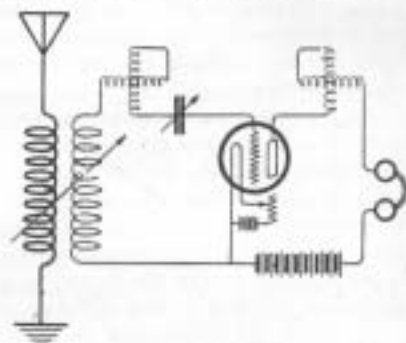

capacity is included in the aerial lead. The variable grid condenser is the usual .0005 or .0005 mfd. The smaller size would be more suitable for Radiotron valves, or for the latter a fixed condenser of .00025 may be substituted. Two fixed condensers of .0005 mfd., each connected in series will serve if there is any difficulty about getting the fixed condenser in the .00025 size.

### A SIMPLE VALVE CIRCUIT.

THIS valve circuit employs a tuning coil wound on a single tube and tapped in two sections. A .001 variable condenser is included in the aerial lead, the grid condenser being of the

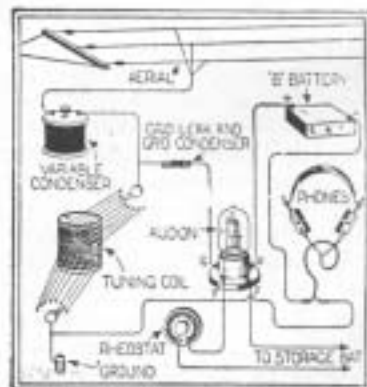

fixed variety. Details were given in the February number of the "Review" for the construction of a tuner made up of spider web coils, and if this tuner is employed, no condenser will be necessary in the aerial circuit, as the tappings as given provide sufficiently fine tuning.



*This is of special interest to*  
**WIRELESS EXPERIMENTERS**

**T**HE Receiving Set illustrated, employing the ARMSTRONG SUPER REGENERATIVE CIRCUIT, was constructed and demonstrated by us with great success at our exhibit in the Royal Easter Show, 1923. This is the first public demonstration of this Circuit in Australia. EXCEPTIONAL results were obtained, no outside aerial or earth used, a small Loop aerial only being required for reception with this Set. Thousands of interested Sydney folk "listened in" to local and Melbourne Concerts.

WE have on hand all necessary parts to construct this Set, including variometers specially designed and wound for this circuit—1250 and 1500 Universal inductance coils—filter coils—transformers and valves.

**THE GENUINE BALDWIN  
 DIAPHRAGM RADIO TELE-  
 PHONE HEADSETS**

are nearest to perfection among electro magnetic receivers. BALDWIN RECEIVERS answer in an unusual way the demand for a receiver which will bring a faithful reproduction of vocal and musical sounds, retaining the pure clear tonal qualities of the original. The amplification, also, is exceedingly great, having the MICA DIAPHRAGM.

Our Special Price, £4/18/6  
 Per Set.

**RADIOTRON VALVES**

As illustrated and described on page 27. Single RADIOTRON W.D. 11 dry cell Tube. The new valve that works on a dry cell instead of that heavy cumbersome six volt accumulator. The ideal valve for the portable set.

Our Price, £2/2/6. Holder, 3/6.



**UNIVERSAL VERNIER  
 RHEOSTAT.**

An absolute necessity to every experimenter using a detector valve that has a certain filament control. This rheostat has a combination of 2 rheostats giving an adjustment of 1/150 of an ohm.

Our Special Price ..... 12/6

**THORDARSON AUDIO FRE-  
 QUENCY INTERVALVE  
 TRANSFORMER**

The Transformer with the aluminum casing, enclosing a ratio of windings of 5 to 1. The transformers have been thoroughly tested and the windings wound with a wire to pass 10 milliamperes.

Our Price ..... £2

**OUR GUARANTEE**

We Guarantee Satisfaction——If any of our customers are not satisfied with our goods after giving them a fair trial, they may return the goods and we will refund the purchase price, together with transportation charges.

\*\*\*\*\* WRITE FOR PRICE LIST \*\*\*\*\*

**Universal Electric Company**  
 244 PITT STREET, SYDNEY.

*At the Sydney Royal Show*



The Universal Electric Company's Fine Exhibit

## AT THE SYDNEY ROYAL SHOW

## The Universal Electric Company

THIS year, the Sydney Show was just a little early to attract a large number of wireless apparatus displays, but at the next one it is quite certain that wireless displays will be the leading feature of the Show.

To grasp the golden opportunity by the forelock is the proclivity of some enterprising souls, and this year's Show was not to pass without at least two firms letting the country people (and the townspeople, for that matter), know that there was such a thing as "wireless" in the air.

The Universal Electric Co., of 244 Pitt Street, Sydney, had a very fine exhibit in the main Show building. A brilliant display was made up of illuminated "vamp" doll electric light stands and shades. The stand itself was made up of what is known as the "Vamp Doll," a saucy-looking young lady, with very wicked dark eyes. The shade was of coloured silk, and the shape of a "vamp" hat. One negress type vamp doll had a little electric motor stowed away in her internal economy somewhere, and she amused the Show visitors by giving a very creditable imitation of that peculiar dance called the "shimmy." Another copper-tinted doll was similarly equipped, and went through the gyrations said to be performed by the Maori wahine when performing the famous war haka.

Amongst the electrical accessories of the exhibit was an Australian invention which has been put on the market by Mr. Fraser, the X-Ray specialist and inventor of the Bristow Coil, the coil which performed such valuable service for returned soldiers who had nerve systems injured at the front.

As the delicate thread like nerves cannot be got at directly for treatment, the Bristow Coil was used to gently undulate the muscular tissue and so stimulate the nerve threads lying in them, to greater activity.

This clever inventor has now produced a full-wave magnetic rectifier for charging motor-car or wireless set batteries direct from the a.c. current lines. The workmanship is a credit to Australian workmen, and the rectifier need only be seen to enable one to judge that it is made for business and that it will stand up to its work. In passing it might be said that the hand painted art silk electric light shades made up the prettiest lighting display seen in Sydney for a long time.

In the wireless section the enterprise of this firm was fully demonstrated. A loop aerial, with an Armstrong Super-Regenerative Receiver and loud speaker were the leading items.

The make-up of the Armstrong made many an amateur's eyes glisten, with its beautifully finished moulded vario-coupler, business-like condensers, and the general high quality and make-up of the set.

Large numbers heard amateur concerts brought in on the loop.

The Company is now stocking the various parts for amateurs who desire to make up their own Armstrong Super-Regenerative Set—and who won't?

The Australian made valve, manufactured by the G. & R. Company, was another feature which called forth a great deal of comment.

This valve is said to be equally effective as a detector or an amplifier, and retails at 27/6.

The new dry cell valve, the Radiotron W. D. 11, was on view, and is the ideal thing for a portable set. Thordarson Transformers, Federal Transformers, both radio and audio-frequency, moulded valve sockets, Radiotron U.V. 200, 201, and Cunningham 5 watt valves, Baldwin Mica Diaphragm phones, and Franco dry batteries, were amongst the stock on exhibition, and the whole make up of the stand was a tribute to the enterprise and initiative of the Universal Electric Co.

## The Western Electric Company's Display

ONE of the most comprehensive exhibits in the electrical line at the Sydney Show was that of the Western Electric Company.

The first thing to strike the eye was a self-contained lighting plant—the kind of plant so much in use in the homestead in the farming districts, where line current is not available.

On the left was the set of accumulators being charged by the plant. These electric lighting sets have come into such general use in America that all kinds of fittings are now manufactured to suit the voltage developed, which is usually around 32 volts.

At this voltage, fans, radiators, lamps of all powers, vacuum cleaners, in fact, every kind of electrical convenience is now available to run on the 32 volts current.

Without any noise, and without missing a stroke, the Western Electric engine, attached to the dynamo made by the same Company, silently ticked away, charging up the accumulators from which the farmhouse can be lit in the evening, instead of depending on the old-fashioned kerosene lamp, with its attendant dangers.

Now that radio is about to invade the backblocks of Australia, this kind of electric generating plant is likely to come into general use with Australian farmers, who will combine the advantages of having an efficient lighting and power system with the benefits of receiving radiophoned weather and market reports. The plant will furnish both the "A" and "B" battery current for his valve receiver, with suitable resistance.



**M**ANKIND, from the earliest recorded ages has been engaged in a ceaseless struggle against the limitations of time and space.

The records of man's progress prove him to be the conqueror. That he has conquered space is proved by the amazing results achieved by wireless.

The Western Electric Company have contributed to this achievement in no small measure.

Take the "Western Electric" Headset, as illustrated above, a marked advance in such an important piece of apparatus if only for comfort, cleanliness and lightweight. Each one before it leaves the factory must pass an exacting test, failure in any degree to do so means its rejection.

*Western Electric Company*  
(Australia) Ltd.

192 CASTLEREAGH STREET, SYDNEY

VICTORIA—C. R. Foster, 568 Bourke Street, Melbourne  
QUEENSLAND—T. Tonka, Elizabeth Street, Brisbane  
SOUTH AUSTRALIA—Unbehun & Johnston, 100 Currie St., Adelaide  
WEST AUSTRALIA—Unbehun & Johnston, 37 King Street, Perth

*Makers of over  
half the worlds  
telephones*

On the right of the display was a courteous young lady who explained the working of a Western Electric motor applied to a sewing machine. Many of the lady visitors looked on with envious eyes to see the ease with which the sewing could be done with the tiny motor.

A little further along was a typical dish-washing machine, fitted with a glass lid through which the

action of the machine on the dishes within could be plainly seen.

An electric washing machine with an electrically driven wringer came in for a lot of attention, an attendant demonstrating the working of it, from time to time.

All kinds of electrical cooking apparatus, electric irons, and appliances of every description made up an exhibit that was of an essentially practical nature.

## Mark Foy's Exhibit



THE brilliant electric lighting provided for the evening sessions of this year's Sydney Show is said to account for the vastly increased attendance, and a still more brilliant lighting scheme is promised for next year.

Of the individual electric lighting exhibits, that of Mark Foy's stood out as unique in its general arrangement and tastefulness.

For the first time in Australasia, the new lead-light electric light fittings were on view. In the shades of these fittings, every imaginable pattern and blending of colours had been requisitioned, and

the effect was gorgeous in the extreme. Tiny pieces of glass of various colours, blended into one artistic and harmonious whole, in every case, and framed by the lead supports, such as are used in making up stained glass windows, were the leading construction points of the new shades. These elements were worked up into electric light shades of every kind of shape and size, and they are certainly the very last thing in the electrical supplies manufacturers' art. In some of these shades, very beautiful sea-shells have been blended with the stained glass, and the startling effect of a brilliant electric light within

these shades must be seen to be fully appreciated. Now that the Show is over, all these fittings have been placed in the electrical goods showroom at Mark Foy's, in Elizabeth Street, Sydney, where the courteous manager of the Department will be pleased to show customers or others these new designs, amongst which will be found just that touch of colouring that will blend with the furnishing scheme you have planned.

Amongst the novelties exhibited was the Universal lamp. This is a stand lamp which is provided with a hook by which it may be hung in any convenient position, such as over a bed rail, or on the back of a chair. It may be used as a wall bracket, a slotter hanger being attached for the purpose. The lamp itself may be swung into any position and a switch is provided so that it may be switched off or on without having to go to the wall switch. One very novel feature is that the long length of flexible cord may be coiled up in the base of the lamp, out of sight, and only so much of the cord left out as is necessary to attach it to the nearest socket. Another novelty is the provision of a rubber suction cup in the base, actuated by a plunger which, when pressed, causes the lamp base to adhere to any smooth surface—a precaution against it being accidentally knocked over. A parabolic reflector permits the beam of light to be concentrated wherever desired and, at the same time, affords grateful shade for the eyes.

The Universal Lamp retails at 21/-. Another table lamp was one with elaborately embossed brass fittings. This was a very handsome article and would grace any drawing room. The shade was a long pattern opalescent one, the side nearest the eyes having a pleasing hand-painted water scene on it. The "Horax" was a lamp intended for study or office use. In it the electric globe is set horizontally, the dark green shade giving the "line-o'-light" effect. The base was balanced, permitting the lamp to be used at any angle.

All kinds of radiators were included in the exhibit, the cheapest and most effective style being a double element radiator, which sells at 45/- and consumes but 800 watts per hour, while giving off more than sufficient heat to warm a good-sized room. On the power meter this radiator would cost only 1½d per hour to run—cheaper than coal and wood! It has a bright copper reflector and is, altogether, a very desirable article.

A vacuum cleaner on view was provided with the usual accessories for cleaning carpets, dusting walls, pictures, &c., and in addition had a new attachment for propelling air to dry anything which had been cleaned by water.

Everything electric, from immersion heaters to electric stoves, was included in Mark Foy's display, which was crowded during every day of the Show.

*Ericsson*

## The Unrivalled Head-Phone for Wireless Telegraphy & Telephony

BRITISH MADE

**ROBUST and RELIABLE**

**THE LAST WORD IN EFFICIENCY.**



THE ERICSSON Head-Phone consists of two Double Pole Watch Pattern Receivers attached to adjustable Head-band, two-way flexible Cord 6 feet long. The Receivers are connected in series.

These 'phones were adopted as Standard by the British Admiralty as far back as 1909 and by the Air Board for Wireless Telephony in Aeroplanes in 1917. Many improvements have since been made.

The Ericsson Company is one of the World's pioneer telephone manufacturing companies and its accumulated experience is behind each Receiver.

**ERICSSON TELEPHONE MFG. CO.**

7 Macquarie Place, Sydney

509 Collins St., Melbourne.



## The Home Electric

THE other firm which had wireless goods on exhibition at the Sydney Royal Show was The Home Electric of 106a King Street, Sydney. The exhibit, which was an exceedingly fine and comprehensive one, was in the avenue just outside the main building, and attracted a great deal of attention. Visitors were brought to a halt by an array of the most artistically designed electric light fixtures, with their opalescent glass-shades, fluted or embossed, and decorated with delicate filagree or floral designs, or with beaten copper framework holding painted



quaint Dutch scenes. Lighting in the home is no longer a mere matter of lighting. With the destructive fumes of gas banished, and the danger of oil lamps out of the way, electricity has permitted the art worker in metal, the artist designer of glass-

ware, and the blender of harmonious colours in silk to bring their best efforts to the service of those whose ideal is the home beautiful. Surely the taste of the most fastidious would be titillated by the beautiful display of electric light fittings on view at The Home Electric stall. Side by side with the artistic display, electric goods of domestic utility were provided for the information of the visitors to the Show.

The Hoover Suction Sweeper came in for its full meed of attention, and the effective action of this vacuum cleaner probably caused more surprise amongst the Show visitors than anything else.

When they were told that it would pull flour right through a carpet, their scepticism was plainly visible, but a demonstration soon convinced them that no speck of dust (even so fine a speck as a speck of flour) could remain behind once the Hoover had passed.

In the wireless section we noticed a compact Federal two-valve receiver. This set was only about 9 inches by 5 inches by 5 inches, and was equipped with the well-known Federal Audio-frequency Transformer, and all the wiring was carefully insulated with spaghetti tubing. There were De Forest three coil holders both in the table and panel patterns; modulation transformers, small pattern volt and ammeters, Paragon valve units complete with holder, grid leak and rheostat, valves of various patterns, moulded valve holders, enamelled resistances, condensers, and a host of parts of both Federal and De Forest manufacture, which are well worth inspecting. All these goods are now on view at the show-rooms of The Home Electric, 106a King Street,

### AMATEUR TRANSMISSION IN MELBOURNE.

FOR a week or so a number of Melbourne amateurs have been sending experimental music, &c., on Monday, Wednesday, Thursday, and Friday evenings. This was to be continued until the end of April, and from May 1st until after the Trans-Pacific Tests, no amateur transmission will be done, in order to give those taking part in the Tests every opportunity of calibrating their apparatus ready for the great trial. As soon as the Tests are over, transmission will begin again on similar lines, and for the purpose of reference the following times and transmitting call signs are given:—Mondays, 7.30 p.m., 3 B.M.; Wednesdays, 8 p.m., 3 B.Q.; Thursdays, 7.30 p.m., 3 J.U.; and 8.50 p.m., 3 B.Y.; Fridays, 7.30 p.m., 3 B.M., and 9.15 p.m., 3 B.O.

## Government Savings Bank

of New South Wales and Rural Bank

Head Office: 19-23 MARTIN PLACE, SYDNEY

156 Branches and 515 Agencies

4% Interest allowed on Savings Accounts up to £500 and  
3½% on any excess to £1000

PERSONAL JOINT TRUST AND  
CHILDREN'S ACCOUNTS OPENED

### RURAL BANK DEPARTMENT

Cheque Accounts opened for any Person, Firm, Company or Institution. Fixed Deposits accepted at Interest up to 5%.

Deposits lent only to Primary Producers.

## Anthony Hordern & Sons' Enterprise

MESSRS. ANTHONY HORDERN & SONS have just completed an electrical and wireless goods showroom on the second floor of the Pitt Street, Sydney, building. As you enter, the various counters are seen for the supply of goods of the different sections of the electrical department. The electric light section is a very large one, and embraces every fitting and refinement necessary for direct, semi-indirect or indirect lighting. Shades of all colours and designs are in profusion and it would indeed be a very exacting individual whose taste could not be met out of such a display. Still, there are people with individual tastes, who prefer to design their own shades, both as to shape and colours, and in this case the firm places its electrical staff at the service of the customer and any kind of shade in any colour or colours will be made up on the necessary particulars being supplied. In fitting up this section, a decidedly novel feature has been incorporated. In the ordinary showroom, a number of shades are lit up from one switch, and amidst the confusion of shapes and colours it is often difficult to pick out a shade or fitting which will harmonize with the general furnishing scheme the customer has in mind. In Messrs. Horderns' show room, each specimen shade or fitting has its own switch, so that only one is illuminated at one time, or, one, two or more, in different parts of the display may be switched up for purposes of comparison.

This is a feature which will be found to be very helpful in choosing electric lighting equipment.

Just at the moment there is a particularly fine range of art silk shades awaiting the approval of intending customers. In fittings, the designs run from the plainest to the most elaborate type of embossed metal electroliers, and a range of beautiful table stands and figures in Italian alabaster crown a magnificent display of electric light fittings.

At another counter everything necessary to instal telephones is procurable, a very fine range of highly

efficient internal telephone supplies being on view.

Another section includes all the latest and best of household electrical apparatus. These include vacuum cleaners, radiators, electric irons, electric toasters, electric grillers, electric kettles, and electric stoves of various patterns.

In the Wireless Section, everything possible has been done to meet the requirements of the experimenter. All the leading types of valves, condensers, crystal detectors, inductances, and parts for making up sets may be procured. An aerial has been erected on the roof of the building, 12 feet high at one end and nearly 100 feet high at the other. It is of the twin wire type, with two stranded wires of 7/20 gauge, and is 240 feet in length. The lead-in wires are brought to a room which has been set apart for the convenience of amateurs, who may take their sets along and test them on the big aerial. "A" battery current is supplied.

The section includes storage batteries for "A" battery purposes, either of the celluloid type or the heavy duty kind.

The celluloid batteries are of the well-known C.A.V. brand, a guarantee of faithful service, and the heavy duty battery is the 6 volt or 12 volt type manufactured by the famous Columbia Company. Either kind of battery can be had in a variety of amperage sizes. It will be remembered that the Columbia storage cell is a favourite one for the heavy duty necessarily associated with motor-car requirements, and is therefore the right kind of battery for the heavy duty of running say a three, four, or six valve receiving set, with a loud speaker added.

If an amateur is in doubt as to whether a fault in his set is due to the set itself, or due to a faulty aerial, he can easily settle the question by availing himself of the testing room services, so thoughtfully provided, free of all charges, by Messrs. Anthony Hordern & Sons.

## Answers to Correspondents

A. J. Richards, Sarina, via Mackay, Queensland.—Your sub. received and copies from the January issue will be posted as you desire. When you receive all the copies of the "Review" you will have a mass of information which will help you to start in wireless, and any further information you desire will be gladly given.

E. O'Halloran, 13 1st Avenue, Mt. Lawley, Perth.—Thanks for the photo of the Apperross Station, which we will be pleased to insert in the "Review." Just at the present we find that we have not the space for the comic side of radio, but when all you amateurs get that subscription list filled up, we will have plenty of space for all purposes.

N. W. Ramsay, P.O. Laura.—If you will turn up page 35 of the April "Review" you will find a diagram of the connections you require. At X, place the Skinderviken button on one of the earpieces of your headset and carry A and B to the loud speaker, which may be a gramophone horn, with the other earpiece used as a microphone.

F. E. Miller, Murray Bridge Radio Society.—Thanks for the photos, which we will have pleasure in inserting.

W. E. Ford, Power Station, Moonta, South Aus.—Regarding your enquiry re the article, "A Three Valve Receiver," in the March "Review," if you will address any further enquiries you may wish to make, concerning the wiring, etc., to the Editor, your letter will be forwarded to the proper quarter. With 'phones, the set should bring in radio telephony up to 500 miles at least. Melbourne amateurs are receiving Mr. MacLurean, Sydney, on under 9 watts power input with single valve receivers.

A. Shearer, Rushmore, Hall Street, Alderley, Brisbane.—Your short story is a meritorious one, but at this stage of the "Review" we have no spare space for the lighter vein of radio. When we enlarge we will be pleased to hear from you again. We return your MSS.

J. Green, "Avoca," Yeronga, Brisbane.—The ideal set for your purpose should be one stage radio-frequency, detector and one stage audio-frequency, and with this you should be able to bring in the Sydney stations you mention. You will find a circuit for the three-valve receiver mentioned in the March "Review," page 23. Your aerial should prove very efficient on the particulars you give.

Chas. E. Pinney, Lands Dept., Port Moresby, Papua.—The valve you mention is not suitable for the Armstrong Super-Regenerative Circuit, only hard valves being permissible.

E. W. Binsell, Cowra.—Our congratulations on the esprit de corps which has prompted you to send your little kink along for the benefit of your fellow experimenters. We have published a paragraph on another page dealing with what you communicate.

We have received a photograph of a child listening, in, without any name, address or description. Will sender please communicate.—Editor, Review.



## Here is the Receiving Set You Have Been Waiting For

*This is an ideal set for the Amateur, and as our stocks will be snapped up quickly, do not delay sending in your order.*

BRITISH MANUFACTURE

### New System Receiving Sets

THIS set is handsomely finished in HAND-POLISHED WALNUT, and is suitable for any wave length up to 650 metres. It is fitted with our "Everset" Patent Automatic Crystal Detector, which needs no adjustment and is always in position. Size 5½ in. x 5 in. x 5½ in. Complete with 2,000, 4,000, or 8,000 ohms "De Luxe" Head-phones, as shown here.



### The Patented "Everset" Detector

THIS new Detector is made up in cartridge form, like a small fuse, and is held between two clips. The leading feature of the invention is that instead of depending on means of finding one sensitive spot on the crystal, a number of points of contact are always available. Consequently the Detector is automatic in its adjustment, as one of the points of contact can be relied upon to provide the necessary rectifying action at maximum sensitiveness. With the "Everset," all that is necessary is to tune in—the crystal is always ready. The Detector is only supplied when fitted to a complete unit.

Price £9/5/-

### 'New System' Head Telephones

THESE are of Super Quality, the result of over a quarter of a century's experience in the manufacture of Telephones. They are simple in design and sturdy in construction.

Every Telephone is tested under actual reception conditions before leaving the works.

120, 1,000, 2,000, 4,000 and 8,000 ohms.

Price £2/5/-

54  
MARKET  
STREET,  
MELB.

Telephone:  
CENT. 11130

**NEW SYSTEM  
WIRELESS**

280  
Castlereagh  
Street,  
SYDNEY.

Telephone:  
CITY 8556